



Australian Government

**Department of Infrastructure, Transport,
Regional Development and Communications**

Discussion Paper

Safer freight vehicles

April 2021





© Commonwealth of Australia 2021
April 2021 / INFRASTRUCTURE

Ownership of intellectual property rights in this publication

Unless otherwise noted, copyright (and any other intellectual property rights, if any) in this publication is owned by the Commonwealth of Australia (referred to below as the Commonwealth).

Disclaimer

The material contained in this publication is made available on the understanding that the Commonwealth is not providing professional advice, and that users exercise their own skill and care with respect to its use, and seek independent advice if necessary.

The Commonwealth makes no representations or warranties as to the contents or accuracy of the information contained in this publication. To the extent permitted by law, the Commonwealth disclaims liability to any person or organisation in respect of anything done, or omitted to be done, in reliance upon information contained in this publication.

Creative Commons license

With the exception of (a) the Coat of Arms; (b) the Department of Infrastructure, Transport, Regional Development and Communication's photos and graphics; and (c) Figures 2, 5, 6, 7, 9 and 10, copyright in this publication is licensed under a Creative Commons Attribution 4.0 Australia Licence.

Creative Commons Attribution 4.0 Australia Licence is a standard form licence agreement that allows you to copy, communicate and adapt this publication provided that you attribute the work to the Commonwealth and abide by the other licence terms.

Further information on the licence terms is available from <https://creativecommons.org/licenses/by/4.0/>

This publication should be attributed in the following way: © Commonwealth of Australia 2020

Use of the Coat of Arms

The Department of the Prime Minister and Cabinet sets the terms under which the Coat of Arms is used. Please refer to the Commonwealth Coat of Arms - Information and Guidelines publication available at <http://www.pmc.gov.au>.

Contact us

This publication is available in PDF format only. All other rights are reserved, including in relation to any Departmental logos or trade marks which may exist. For enquiries regarding the licence and any use of this publication, please contact:

Director - Publishing and Communications
Communications Branch
Department of Infrastructure, Transport, Regional Development and Communications
GPO Box 594
Canberra ACT 2601
Australia

Email: publishing@infrastructure.gov.au

Website: www.infrastructure.gov.au

Contents

Purpose	1
Executive Summary.....	2
Introduction.....	3
Road vehicle regulation in Australia.....	3
ADR development and review	3
Performance Based Standards (PBS) Schemes.....	4
Heavy freight vehicle sales in Australia by country/region of manufacture	4
The National Road Safety Action Plan 2018-2020.....	4
Network capacity for wider vehicles	5
Austroads' review of heavy freight vehicle dimensions.....	5
Lane widths in Australia compared to other countries with wider vehicles.....	6
Impediments to the supply of safer and cleaner freight vehicles.....	6
Vehicle width.....	7
Devices for indirect vision and monitoring devices to detect other road users.....	8
Vehicle axle configuration.....	10
Proposed changes to the ADRs	17
Regulatory package for vehicles with enhanced devices for indirect vision and/or monitoring devices to detect other road users	17
Regulatory package for safer wider heavy freight vehicles.....	19
Regulatory package for vehicles with more efficient and/or productive axle configurations	22
Next steps	24
References.....	25
Appendix 1 – Glossary	28
Appendix 2 – Summary of vehicle width requirements by market.....	32
Appendix 3 – Devices for indirect vision	37
Appendix 4 – Electronic Stability Control.....	41
Appendix 5 – Advanced Emergency Braking.....	45
Appendix 6 – Lane Departure Warning Systems.....	48
Appendix 7 – Blind Spot Information Systems	49
Appendix 8 – Side underrun protection.....	50
Appendix 9 – Conspicuity markings.....	53



Purpose

This paper seeks stakeholder feedback on possible regulatory changes to facilitate an increased take up of safer and cleaner heavy freight vehicles in Australia. It directly relates to Other Critical Action L – Investigate the introduction of safer, cleaner heavy freight vehicles by minimising regulatory barriers, of the National Road Safety Action Plan 2018-2020 (Australian Government, 2018a), and to Action 1 in the National Heavy Vehicle Regulator’s Vehicle Safety and Environmental Technology Uptake Plan (Vehicle SETUP) (NHVR, 2020).

Key dates:

Due date for submissions: **Wednesday 30 June 2021**

Submissions can be made:

By email: standards@infrastructure.gov.au

By post: Vehicle Standards
Vehicle Safety Policy and Partnerships Branch
Department of Infrastructure, Transport, Regional Development
and Communications
GPO Box 594
CANBERRA ACT 2601



Executive Summary

Responsibility for vehicle regulation is shared between the Australian Government and the states and territories.

The Australian Government regulates the first supply of vehicles to the Australian market. New road vehicles are required to meet national vehicle standards known as the Australian Design Rules or ADRs, before they can be offered to the market for use in transport.

Once a vehicle is approved and supplied to the Australian market, regulation passes to the relevant state or territory governments or the National Heavy Vehicle Regulator, which are responsible for in-service requirements such as registration, road-worthiness, and vehicle modifications, including upgrades. In-service vehicle standards rules/regulations require, as a general principle, that vehicles continue to comply with the ADRs.

At the 18 May 2018 meeting of the then Transport and Infrastructure Council, Ministers endorsed the National Road Safety Action Plan 2018-2020, which includes a commitment to investigate the introduction of safer, cleaner heavy freight vehicles by minimising regulatory barriers.

This paper identifies possible changes to the ADRs to facilitate an increased take up of safer and/or more efficient heavy freight vehicles in Australia. This includes options for:

- vehicles with enhanced devices for indirect vision and/or monitoring devices to detect other road users;
- safer wider vehicles – including four options, each with proposed new safety requirements; and
- vehicles with more efficient and/or productive axle configurations.

These changes are expected to have a positive impact on road safety, while reducing regulatory burden. If implemented, there would be less need for manufacturers to re-design or modify vehicles available in other markets, which would make it easier and cheaper for many manufacturers to supply vehicles fitted with the latest safety and emission control technologies to the Australian market. The additional safety systems would help drivers to be more aware of their surrounds, including to avoid and/or mitigate the severity of any collisions with other road users. Further, the changes proposed in relation to vehicle axle configuration would help manufacturers to supply vehicles that are more efficient and/or productive, including vehicles able to complete the same freight task in fewer trips, which reduces both transport costs and exposure related crash risks.

The publication of this discussion paper provides an opportunity for all interested parties to respond by submitting comments to the Department. Submissions close on **Wednesday 30 June 2021**.



Introduction

Road vehicle regulation in Australia

Responsibility for vehicle regulation is shared between the Australian Government and the states and territories.

The Australian Government regulates the first supply of vehicles to the Australian market. Under the existing *Motor Vehicle Standards Act 1989* (MVSA) (Australian Government, 2016a), new road vehicles are required to comply with national vehicle standards known as the Australian Design Rules (ADRs), before they can be offered to the market for use in transport in Australia. The *Road Vehicle Standards Act 2018* (RVSA) (Australian Government, 2019) is being phased in over coming months to replace the MVSA, to deliver an updated and modernised system to regulate the first provision of road vehicles to the Australian market. The RVS legislation will commence in full on 1 July 2021. From this date, there will be a 12-month transitional period, during which transitional arrangements will be in place that allow some approval holders to continue operating under existing approvals. Each ADR in force under the MVSA, immediately before commencement of the RVSA, will continue in force as a national road vehicle standard under the RVSA.

The ADRs set requirements for vehicle safety, environmental performance and theft protection in line with community expectations. Through the Department's road vehicle certification system, new vehicle types (models) manufactured in or imported to Australia are assessed and certified as complying with the applicable ADRs. Once the vehicle type has been approved, new vehicles of that type are then permitted to be supplied to the market.

Once vehicles have been supplied to the market, responsibility for regulation (e.g. vehicle registration, in-service standards and operations) passes to the states and territories. This is principally done through legislation based on the Australian Light Vehicle Standards Rules and the Australian Road Rules, which are managed by the National Transport Commission, and the Heavy Vehicle National Law (Queensland Government, 2020a), which is administered by the National Heavy Vehicle Regulator (NHVR). Both the Australian Light Vehicle Standards Rules and the Heavy Vehicle National Law have as a general principle that vehicles will continue to comply with the relevant ADRs.

ADR development and review

Since the mid-1980s, the ADRs have been progressively harmonised with internationally based United Nations (UN) vehicle regulations, which are developed by the UN World Forum for Harmonization of Vehicle Regulations. Harmonisation is important because Australian vehicle sales represent less than one per cent of the global vehicle market. Harmonising with international vehicle regulations provides Australian consumers with access to the safest vehicles from the global market at the lowest possible cost.

There is an ongoing program of work to develop, review and revise the ADRs. To ensure the ADRs remain fit for purpose, the Department monitors international developments and regularly consults with stakeholders, including to identify any implementation issues or changes in factors affecting existing ADRs, as well as benefits associated with introducing new ADRs.

Performance Based Standards (PBS) Schemes

Australia also has two voluntary PBS schemes for heavy vehicles, which are administered by the NHVR and the Western Australian Government. Under these schemes, vehicles are tested against 16 additional safety standards and 4 infrastructure standards, and can receive exemptions from meeting specified clauses of the ADRs and in-service vehicle regulations, including standard limits for vehicle width, length, height and rear overhang, as well as various tow coupling related requirements. These PBS schemes give industry the opportunity to innovate with vehicle design to improve productivity and achieve safer performance while minimising impacts on the environment and road infrastructure. PBS vehicles are permitted to operate on defined road networks that are appropriate for their performance (NHVR, 2019).

Heavy freight vehicle sales in Australia by country/region of manufacture

In Australia, over 90 per cent of medium trucks are imported from Japan. Around two thirds of heavy trucks are imported, mostly from Japan or Europe, and around a third of heavy trucks are made locally. Figure 1 shows trucks sales in Australia by country/region of manufacture for 2020.

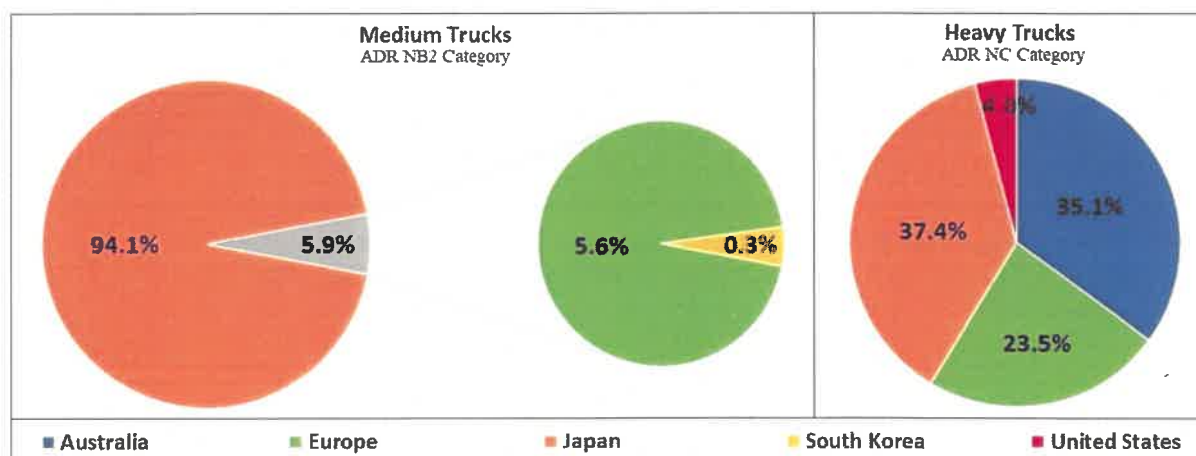

Figure 1 - Truck sales in Australia (2020) by country/region of manufacture (source: supplied by the Truck Industry Council)

Around 90-95 per cent of heavy trailers are made in Australia.

The National Road Safety Action Plan 2018-2020

At the 18 May 2018 meeting of the then Transport and Infrastructure Council, Ministers endorsed the National Road Safety Action Plan (NRSAP) 2018-2020 (Australian Government, 2018a), which includes Other Critical Action L to investigate the introduction of safer, cleaner heavy freight vehicles by minimising regulatory barriers. The aim of the action is to increase take up of safer, cleaner heavy freight vehicles (goods vehicles over 4.5 tonnes Gross Vehicle Mass (GVM) and trailers over 4.5 tonnes Aggregate Trailer Mass (ATM)) in Australia.

Other Critical Action L (NRSAP 2018-2020):

Investigate the introduction of safer, cleaner heavy freight vehicles by minimising regulatory barriers

The overall age of the heavy vehicle fleet has an impact on safety as newer vehicles have more safety features. It is proposed to investigate ways to encourage the greater uptake of newer, safer, cleaner vehicles into the Australian fleet, including regulatory requirements and the capacity of the road network to accommodate different sizes of vehicles. To meet current Australian regulations, heavy freight vehicles must be 50 to 100mm (2-4%) less in width than vehicles in other major markets. This costs manufacturers \$15-30 million per year to redesign their vehicles, and in some cases reduces the availability of safer, cleaner models.

Regulatory restrictions exist in Commonwealth and state and territory regulations, and include both vehicle size and mass. They were originally introduced to protect infrastructure such as roads, building clearances, and bridge loading limits, and to prevent head-on crashes and reduce conflict with other road users on narrower roads. All parties will examine current regulatory requirements, as well as network capacity for vehicles of different size and mass, where the roadway can safely (sic) accommodate such vehicles and minimise crashes. Subject to this assessment, the Commonwealth will release a discussion paper, ahead of a regulatory package for any agreed changes to heavy freight vehicle width and any other dimensions, and axle transitional mass, in the Australian Design Rules. The NHVR and the state and territory governments will consider additional changes to heavy freight vehicle size and axle mass limits. The aim is to achieve increased take up of safer, cleaner heavy freight vehicles in Australia from a reported 0.1% to be closer to the global average of 2.0%, also leading to a lower average age of the heavy vehicle fleet.

Network capacity for wider vehicles

Austrroads' review of heavy freight vehicle dimensions

Austrroads conducted a review of heavy freight vehicle dimensions in 2019 (Austrroads, 2019). This review concluded there is a positive case to increase the Australian maximum allowable heavy freight vehicle width from 2.5 m (current) to 2.55 m. Vehicles currently operating up to 2.55 m in width in New Zealand (or the EU or the UK), or under permits or exemptions in Australia, are not more likely to be involved in crashes. This is particularly relevant as there are many narrow roads, with narrow lane widths in New Zealand, the EU and the UK, including many pre-20th century designed roads in the case of the EU and the UK.



Negative economic impacts reported in regard to restricting vehicle width to 2.5 m in Australia include increased costs of procuring new vehicles, increased costs of operation for modified vehicles, and to a smaller degree, an increased number of trips required to transport the same load. There is also additional regulatory burden for industry to get exemptions or permits for wider vehicles, and for governments to administer these arrangements. The review also identified that the modification of imported vehicles to meet the 2.5 m width limit in Australia can have negative safety impacts, including adding costs that slow the penetration of newer vehicles with modern safety technologies, and preventing the installation of safety technologies that extend beyond the current 2.5 m width limit.

The consultation undertaken with stakeholders as part of the review indicated that there is majority support for a change in policy to allow all heavy freight vehicles to operate to a maximum width of 2.55 m. However, in some cases this support was conditional on additional safety technologies being mandated as part of any change to increase the width limit. Other stakeholders argued strongly for a 2.6 m width limit to be adopted instead. Austroads recognised that this would provide additional benefits for some in the freight industry, especially the operators of refrigerated vehicles, and recommended that an option to allow some vehicles up to 2.6 m be considered after the 2.55 m relaxation has been proven on the network.

Lane widths in Australia compared to other countries with wider vehicles

Standards for local, highway and arterial road lane widths in Australia are comparable to those in the EU, UK and US, where vehicles are permitted to be up to 2.6 m wide. Austroads' Guide to Road Design Part 3: Geometric Design (Austroads, 2016), notes that current practice in Australia and New Zealand is to provide standard traffic lane widths of 3.5 m. A wider lane width of 4.2 m is recommended for arterial roads with high truck volumes. Freeways should include a 3 m road shoulder to allow a truck to stop clear of the traffic lane (Austroads, 2016). Motorways in the EU and the UK typically have lane widths of 3.5 to 3.75 m (European Road Safety Observatory, 2018), but can be narrower, with the UK guidance suggesting that, where unavoidable, lane widths can be decreased to 3.3 m (Highways England, 2020). Guidance for the width of most non-motorway roads in the EU is 3.5 m (SWOV Institute for Road Safety Research, 1994). However, there are many narrower roads, particularly in areas around older cities that are still accessed by heavy freight vehicles. In the US, the minimum lane width applied for the interstate system is 3.6 m (AASHTO, 2016), and design guidance for highways and streets suggests lane widths of 3.0 to 3.6 m (AASHTO, 2001).

Impediments to the supply of safer and cleaner freight vehicles

In preparing this paper, the Department has considered information from a range of sources to identify any potential barriers or impediments in the ADRs to the supply of safer and cleaner heavy freight vehicles. Importantly, the Department's review has revealed that the ADRs do not prohibit safer and cleaner heavy freight vehicles from being supplied to the Australian market. Nevertheless, there are some requirements in the ADRs that can make it more difficult and more costly for manufacturers to supply vehicles fitted with advanced safety features, cleaner engines, and/or more productive design features. Further, the relatively small size of the Australian market limits the number of vehicles across which manufacturers can amortise any additional development costs to meet Australian specific requirements.



The main ADR requirement raised by heavy vehicle industry groups as limiting the supply of safer and cleaner heavy freight vehicles is the vehicle width limit. Other key issues raised as priorities for review and amendments include the absence of exclusions for various types of devices for indirect vision (i.e. mirrors and cameras) and blind spot information systems (e.g. for the detection of vehicles, bicyclists and/or pedestrians) from the measurement of vehicle width and/or length, together with a series of legacy requirements in relation to vehicle axle configuration.

Vehicle width

There is no one globally accepted vehicle width limit, nor any international (UN) vehicle regulation covering vehicle width. Instead, there are various (and differing) regional and national requirements that apply for vehicle width, including in Australia and in other countries from which Australia imports heavy freight vehicles. The reason for a vehicle width limit is to ensure vehicles can travel safely on the road network, without colliding with other vehicles (including vehicles travelling in the same or opposite directions), vulnerable road users (e.g. pedestrians, bicyclists etc.) in close-proximity to the vehicle, or roadside infrastructure.

In Japan, vehicle width is limited to 2.5 m. In the European Union (EU) vehicle width is allowed to be up to 2.55 m for all vehicles, and up to 2.6 m for goods vehicles with refrigerated bodywork (with insulated walls of at least 45 mm thick) (EU, 2019). This was increased from a 2.5 m limit for all vehicles in the mid-late 1990s. In the United States (US), vehicles are allowed to be up to 2.6 m wide (US Government, 2020).

In Australia, vehicle width is limited within the ADRs (and through in-service vehicle regulations) to 2.5 m (Australian Government, 2016a), except for non-standard vehicles, subject to conditions including limited network access under permit and/or notice arrangements. This means that vehicles (including components such as axles) and plant equipment (such as cranes) mounted on heavy vehicles have to be made slightly (2-4 per cent) narrower than for vehicles designed to EU and/or US requirements. This adds costs and slows the development of new models for the Australian market. Further, it restricts the space available for manufacturers to fit safety and/or emissions control systems, which can make it more difficult and more costly to supply safer and cleaner models in Australia.

Vehicles based on EU or US market designs (including Australian made trucks) currently make up around 60 per cent of new heavy trucks (over 12 tonnes GVM) sold in Australia and the cost to redesign vehicles for the Australian market has been estimated at \$15-30 million per year (Australian Government, 2018a). There are further costs in lost productivity through reduced transport volumes, non-standardised load sizes and the necessary reduction of wall thickness (and so reduced thermal efficiency) of refrigerated bodywork.

In future there are likely to be a number of design changes made to trucks for the EU and US markets which manufacturers will find increasingly difficult (or at least not economically worthwhile) to adapt to fit within the 2.5 m vehicle width limit for the relatively small Australian market. These include the re-design of truck cabs to provide an improved direct field of view for the driver (including to meet upcoming regulatory requirements proposed by the EU) and batteries and/or hydrogen storage systems for electric trucks made to fit a 2.55 m (or wider) width limit.

Appendix 2 includes a detailed summary of the current vehicle width requirements (and exclusions) in Australia, the EU, Japan, New Zealand, and the US.

Devices for indirect vision and monitoring devices to detect other road users

Similar to the vehicle overall width, there is no one globally accepted set of exclusions from vehicle width and length measurements, including for devices for indirect vision and monitoring devices to detect other road users (e.g. blind spot information systems for the detection of vehicles, bicycles and/or pedestrians). Instead, there are various regional and national requirements that apply throughout the world, including a differing set of exclusions in Australia, the EU, Japan, New Zealand, and the US.

In the EU, all devices for indirect vision (as defined in the UN Regulation No. 46 (UN R46)) are excluded from the measurement of both vehicle width and length (EU, 2019). These include rear view, close-proximity view and front-view classes of devices for indirect vision, which can be conventional mirrors or camera-monitor systems. All devices for indirect vision and the vehicles to which they are fitted must be approved to UN R46, which includes a minimum defined field of view requirement for each class of device (e.g. rear-view, close-proximity view, front-view etc.), together with pendulum impact test requirements for devices mounted less than 2 m from the ground (i.e. those which would be more likely to impact a pedestrian or light vehicle) and protruding more than 100 mm from the side bodywork. Figure 2 shows an example of a camera-monitor system for indirect vision. The external camera is much smaller and lighter than a conventional mirror, which helps reduce aerodynamic drag and makes it less likely to impact with or obscure the driver's view of other vehicles or pedestrians.



Figure 2 – An internal monitor (left) and external camera (right) of a camera-monitor system for indirect vision (source: supplied by Daimler Truck and Bus Australia Pacific)

The EU also allows watching and detection aids (including external elements of blind spot information systems and sensors for automated driving systems) to be excluded from the measurement of the vehicle width and length (EU, 2019), provided:

- the total protrusion of the devices added to the width of the vehicle does not exceed 100 mm; and
- the total protrusion of the devices added to the length of the vehicle does not exceed 250 mm at the front, and 750 mm in total.

In Australia, under the ADR for vehicle configuration and dimensions (ADR 43 / Australian Government, 2016b) and the ADR definitions (Australian Government, 2020), rear vision mirrors (also referred to in the ADRs as rear-view mirrors) are excluded from the measurement of the vehicle width, but not the length. There are no exclusions for other classes of mirrors for indirect vision (e.g. close proximity and front-view mirrors), cameras for indirect vision, or monitoring devices to detect other road users (i.e. detection aids such as blind spot information systems), from the measurement of vehicle width or length. To fit these devices/systems, manufacturers need to make them fit into the already narrower 2.5 m vehicle width envelope for Australia, and/or make the cab or load carrying area of some vehicles shorter than would otherwise be permitted. However, as fitment of blind spot information systems, and close proximity and front-view devices for indirect vision is optional under the ADRs, it can be easier for manufacturers not to fit these, including for many vehicles imported from the EU (where they are standard fitment). Figure 3 and Figure 4 show the minimum additional field of view provided by close proximity (UN Class V) and front-view (UN Class VI) devices for indirect vision, respectively.

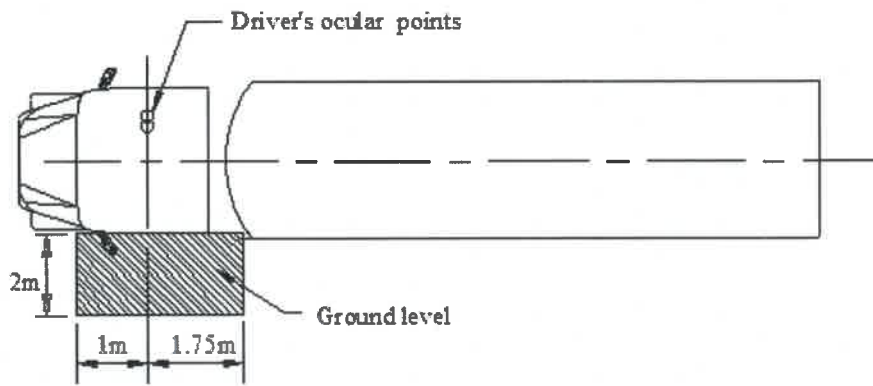

Figure 3 – Minimum required field of view under UN R46 for a close-proximity view (Class V) device for indirect vision (source: adapted (for right-hand-drive) from UN R46)

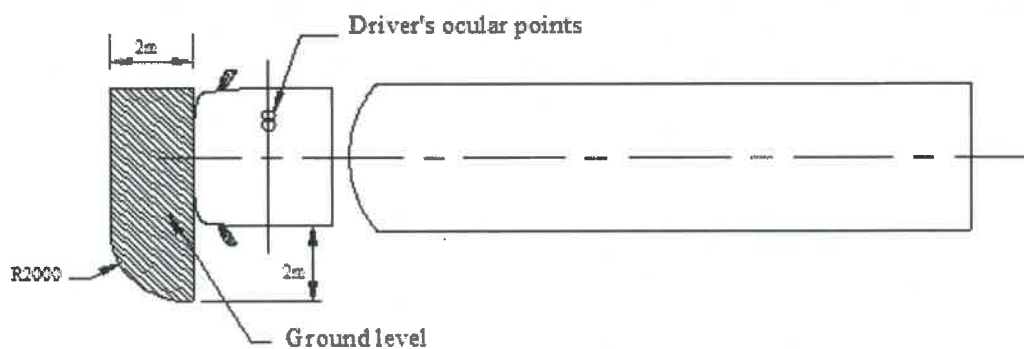

Figure 4 – Minimum required field of view under UN R46 for a front-view (Class VI) device for indirect vision (source: adapted (for right-hand-drive) from UN R46)

In the US, rear view mirrors are excluded from the measurement of vehicle width and length. Cameras for indirect vision, other devices for indirect vision, and blind spot information systems can also be excluded (as non-property carrying devices) from the measurement of vehicle width and length, provided these do not extend more than 3 inches (76 mm) beyond each side or the rear of the vehicle (US Government, 2020).

Vehicle axle configuration

There are also a number of requirements in the ADR for vehicle configuration and dimensions (ADR 43 / Australian Government, 2016b) which can be barriers to the supply of vehicles with more productive, fuel-efficient and/or environmentally friendly axle configurations. All are legacy requirements that were originally transferred into an earlier version of this ADR, from state and territory requirements in the late 1980s. These include limits on axle spacing, axle transition mass (the maximum permissible mass placed on the road by an axle or axle group before any retracted/lifted axle must automatically lower), rear overhang (the distance between the centre of the rear axle or axle group of a vehicle and the rearmost point on the vehicle), and the number of axles in an axle group.

Twin steer axle spacing

Twin steer axle groups can provide benefits for operators, through increasing the permissible load that can be carried during a trip. For example, under the *Heavy Vehicle (Mass, Dimension and Loading) National Regulation* (Queensland Government, 2020b), a twin steer axle with a load-sharing suspension is permitted to carry 11 tonnes, compared to 6.5 tonnes for a single steer axle on a rigid truck. This allows the same freight task to be completed in fewer trips, which (all else being equal) reduces the overall crash risk, fuel consumption and noxious emissions. Figure 5 shows an example of a heavy rigid truck (cab-chassis) with a twin steer axle group.



Figure 5 – A heavy rigid truck (cab-chassis) with a twin steer axle group (source: supplied by Paccar Australia)

Under the ADR for vehicle configuration and dimensions (ADR 43 / Australian Government, 2016b), the distance between the centrelines of the axles of a twin steer axle group is currently required to be at least 1.0 m, but not more than 2.0 m. The purpose of this requirement is to ensure a reasonably even distribution (sharing and spread) of the load between each of the twin steer axles and the road. However, as there is no similar spacing requirement in UN or EU vehicle regulations (or in US vehicle standards), some manufacturers are having to reduce the spacing between twin steer axles for vehicles sold in Australia. This increases the cost of fitting twin steer axles to trucks sold in Australia, which discourages fitment. It also reduces the available space for manufacturers to fit engine and exhaust components, including for example exhaust system after treatment devices to reduce noxious emissions and meet more stringent standards.

Prescribed transition mass limits for vehicles with retractable axles

Retractable axles, which can be raised or lowered relative to other axles in the same axle group, can provide benefits for operators under lightly laden and intermediate load conditions. These include reduced tyre wear and fuel consumption through lower rolling resistance, as well as more balanced braking through more efficient utilisation of adhesion between the tyres of the other (non-retracted) axles in the group and the road. There are also some disadvantages, including the added complexity, cost and weight of the additional components required for a retractable axle. Figure 6 shows an example of a heavy rigid truck with a leading retractable axle.



Figure 6 – A heavy rigid truck with a leading retractable axle (source: supplied by Paccar Australia)

The ADR for vehicle configuration and dimensions (ADR 43 / Australian Government, 2016b) requires retractable axles to automatically lower to the fully-down position no later than when the load imposed by the axle group on the road reaches a prescribed transition mass (which varies by tyre and axle configuration), and to remain in this position while the prescribed transition mass is exceeded. The purpose is to automatically control the loads imposed by the axles to the road, to minimise road wear/damage. However, most of the prescribed transition mass limits in the ADR are significantly lower than the corresponding general mass limit under the *Heavy Vehicle (Mass, Dimension and Loading) National Regulation* (Queensland Government, 2020b). This reduces the benefits available to operators to offset the disadvantages, including additional costs and weight, of fitting a retractable axle. Table 1 shows the current prescribed transition mass limits applicable to vehicles under the ADR together with the corresponding general mass limits that would otherwise apply in-service for heavy vehicle operators. The prescribed transition masses for each of the specified tyre and axle configurations vary between a minimum of 67 and a maximum of 98 per cent of the corresponding general mass limit.

Table 1 – Current prescribed transition masses for retractable axles under the ADR, and the corresponding general mass limits that would otherwise apply under the Heavy Vehicle (Mass, Dimension and Loading) National Regulation, by tyre and axle configuration

Axle Transition	Tyre Type and Configuration before transition	Prescribed Transition Mass (Tonnes) – Current	General Mass Limit (Tonnes)
From 1 axle to 2 axles	Single tyres on each wheel	4.0	6.0
	Wide single tyres (375 to 450 mm section width) on each wheel	6.5	6.7
	Wide single tyres (> 450 mm section width) on each wheel	6.5	7.0
	Dual tyres on each wheel	6.5	9.0
From 2 axles to 3 axles	Single tyres on each wheel	10.0	11.0
	Wide single tyres (375 to 450 mm section width) on each wheel	13.0	13.3
	Wide single tyres (> 450 mm section width) on each wheel	13.0	14.0
	Dual tyres on each wheel	13.0	16.5

Rear overhang for prime movers with a retractable rear axle

Under the ADR for vehicle configuration and dimensions (ADR 43 / Australian Government, 2016b), the rear overhang of any vehicle (the distance between the centre of the rear axle or axle group of a vehicle and the rearmost point on the vehicle) must not be any more than 60 per cent of the wheelbase (the distance between the centreline of the front axle and the centreline of the rear axle or axle group) or 3.7 m, whichever is less. The 60 per cent of wheelbase criterion limits the load space behind the rear axle or axle group, which helps to maintain appropriate load distribution between axles, including on the front axle (to maintain effective steering/control). The purpose of the 3.7 m criterion is to limit the swept path of the vehicle during turning, in particular the swing out of the rear outermost points of the vehicle (tail swing-out).

Retractable axles can be either leading or trailing axles, and in both cases are lazy (non-driven) axles. A leading retractable axle is located at the front of an axle group, while a trailing retractable axle is located at the rear of an axle group. For trucks, a leading retractable axle needs to incorporate a bend around the driveshaft, so the axle can be retracted without interfering with the driveshaft. This adds additional complexity, weight and cost in comparison to a trailing retractable axle. For trailers, there is no driveshaft, so no need for a leading retractable to include a bend. Figure 7 shows the underbody of a truck with a leading retractable axle.



*Figure 7 – Underbody view of a truck with a leading retractable axle (note the bend in the red axle around the driveshaft)
(source: supplied by Hendrickson Asia Pacific)*

Where a retractable axle is fitted, a vehicle has a number of different configurations, and must meet the rear overhang requirements for each of these configurations. In the case of a vehicle with a leading retractable axle, raising this axle will increase the wheelbase and decrease the rear overhang. In the case of a vehicle with a trailing retractable axle, raising this axle will decrease the wheelbase and increase the rear overhang. Figure 8 shows how wheelbase and rear overhang are measured for a rigid truck with a trailing retractable axle in the fully down and retracted positions.

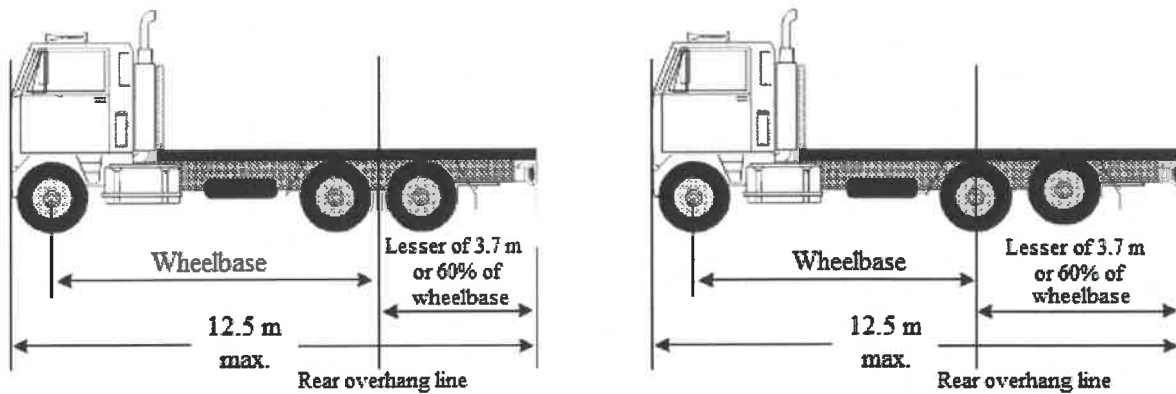

Figure 8 – Illustration of wheelbase and rear overhang for a rigid truck with the rear axle fully-down (left) and retracted (right)

The rear overhang requirements in the ADR are not technically difficult to meet for longer wheelbase prime movers or rigid trucks, but can limit the fitment options for retractable axles on shorter wheelbase prime movers. For example, the Truck Industry Council have advised that fitting a trailing retractable axle to a prime mover with a wheelbase of less than 4.175 m (with the retractable axle lowered) will usually result in the vehicle rear overhang exceeding the 60 per cent of wheelbase limit when the retractable axle is lifted. This limits the uptake of retractable axles for shorter wheelbase (typically cab-over engine style) prime movers in Australia.

There is no rear overhang requirement in UN or EU vehicle regulations (or in US vehicle standards). However, the EU does have performance based test requirements for manoeuvrability and maximum rear swing-out, as well as a requirement for the mass on the front steering axle(s) to be at least 20 per cent of the total vehicle mass, when the vehicle is laden to its technically permissible maximum laden mass (i.e. GVM) (EU, 2019) – which is important to maintain effective steering/directional control. Under these requirements, manufacturers are able to fit trailing retractable axles to shorter wheelbase prime movers than is possible for Australia under the ADR. Figure 9 shows an example of a prime mover with a trailing retractable axle.



Figure 9 – A prime mover with a trailing retractable axle (source: supplied by Scania Australia)

Quad axle groups

The ADR for vehicle configuration and dimensions (ADR 43 / Australian Government, 2016b) also prescribes requirements for the configurations of axles and axle groups that can be used to support vehicles. All motor vehicles must be supported by two axle groups, including either a single axle or twin steer axle group towards the front, and either a single axle, tandem axle group, triaxle group, or close coupled axle group towards the rear. Semi-trailers must be supported by either a single axle, tandem axle group, triaxle group, or close coupled axle group towards the rear. Pig trailers (otherwise known as centre axle trailers) must be supported by either a single axle, tandem axle group, triaxle group, or close coupled axle group towards the centre. Dog trailers (otherwise known as full trailers) must be supported by a single axle, tandem axle group, triaxle group, or close coupled axle group at the front and the rear. With the exception of close coupled groups of four axles (no more than 3.2 m apart), the overall number of axles in a group is limited through this ADR (and the ADR definitions) to a maximum of three. This limit has been set to control the impacts of road scrubbing by tyres on vehicles (when turning), but could otherwise be managed through the fitment of a steerable axle as part of a quad axle group.

Under PBS, approved quad axle semi-trailers are permitted to carry up to 27 tonnes on the quad axle group (including in B-Doubles and other combinations), across a defined (PBS) road network (NHVR, 2017). This enables heavy loads such as meat, wine, grain and other produce to be transported in fewer trips, which reduces the overall crash risk, fuel consumption and noxious emissions. Figure 10 shows an example of a B-Double combination with two quad axle groups, which is used to transport shipping containers under a PBS approval.



Figure 10 – A B-Double combination with two quad axle groups (source: supplied by Vawdrey Australia)

For a quad axle semi-trailer to be eligible for a PBS approval, the quad-axle group must include a load sharing suspension and a steerable axle with at least ± 12 degrees of steering articulation and an effective automatic centring mechanism (or another mechanism proven to be as effective in mitigating the impacts of road scrubbing by tyres). Further, the distance between the centrelines of the front and rear axles of the quad axle group must be between 3.2 m and 4.9 m (NHVR, 2017).

PBS approved quad axle semi-trailers are also permitted to carry up to 20 tonnes on the quad axle group under general access provisions, provided all mass and dimension requirements under the *Heavy Vehicle (Mass, Dimension and Loading) National Regulation* (Queensland Government, 2020b) (NHVR, 2017), or in NT or WA law, are met.

Proposed changes to the ADRs

There are a number of changes that could be made to the ADRs to encourage an increased take up of safer and cleaner heavy freight vehicles in Australia. As set out in the previous section, these include options for:

- vehicles with enhanced devices for indirect vision and/or devices to detect other road users;
- wider vehicles meeting additional safety requirements; and
- vehicles with more efficient and/or productive axle configurations.

The Department expects that these changes would have a positive impact on road safety while reducing regulatory burden. If implemented, there would be less need for manufacturers to re-design or modify vehicles available in the EU and other markets for Australia, which would make it easier and cheaper for many manufacturers to supply vehicles fitted with the latest safety (and emission control) technologies to the Australian market. While these vehicles could be slightly (2-4 per cent) wider and/or be fitted with safety devices that protrude a little further from the vehicle body, the additional safety systems would help drivers to be more aware of their surrounds, including to avoid collisions with other road users. Further, the changes proposed in regard to vehicle axle configuration would help manufacturers to supply vehicles that are more efficient and/or productive, including vehicles able to complete the same freight task in fewer trips, which reduces both transport costs and exposure related crash risks.

Regulatory package for vehicles with enhanced devices for indirect vision and/or monitoring devices to detect other road users

To facilitate a greater supply and take up of vehicles with devices and systems to help the drivers of these vehicles to see and/or be aware of the presence of other road users, including cyclists and pedestrians, the Department is seeking any feedback/comments on a proposal to amend the ADRs to:

- Exclude all of the following devices and systems from the measurement of the vehicle width:
 - rear vision mirrors¹ (also referred to in the ADRs as rear-view mirrors);
 - devices for indirect vision, fitted in accordance with a new ADR 14/03 – Devices for Indirect Vision (or any later version of this ADR);
 - any other devices that help the driver to see objects in an area adjacent to the vehicle, including crossover mirrors (subject to a total protrusion limit below); and
 - monitoring devices fitted as part of an automated driving system and/or a system to inform the driver of the presence of other road users (e.g. vehicles, bicyclists, pedestrians) in an area in close-proximity (within 2 m) to the vehicle body (subject to a total protrusion limit below).

¹ Rear vision mirrors are already excluded from the measurement of the vehicle width and would continue to be excluded under this proposal.

- Limit the total (left + right side) protrusion of all devices except for rear vision mirrors, devices for indirect vision, and central tyre inflation systems, excluded from the width of the vehicle, to a maximum of 100 mm (to align with the total protrusion allowed by the EU).
- Exclude all of the following devices and systems, where fitted at the front end of the vehicle, from the measurement of vehicle length:
 - devices for indirect vision, fitted in accordance with a new ADR 14/03 - Devices for Indirect Vision (or any later version of this ADR);
 - any other devices that help the driver to see objects in an area adjacent to the vehicle, including crossover mirrors (subject to a protrusion limit below); and
 - monitoring devices fitted as part of an automated driving system and/or a system to inform the driver of the presence of other road users in an area in close-proximity (within 2 m) to the vehicle body (subject to a total protrusion limit below).
- Limit the protrusion of all devices except for devices for indirect vision, excluded to the front of the foremost point from which vehicle length is measured (the vehicle 'front end' – see glossary), to a maximum of 250 mm (to align with the forward protrusion allowed by the EU).

The new ADR 14/03 would incorporate the technical requirements of the latest version of the relevant international standard for devices for indirect vision (UN R46/04), with additional provisions to allow for US style crossover mirrors (refer Glossary in Appendix 1) to be used on bonneted trucks in place of UN style front-view devices for indirect vision. As per UN R46, devices for indirect vision would need to meet pendulum impact test requirements, where fitted less than 2 m from the ground, and protruding more than 100 mm from the vehicle bodywork. For a mirror and/or camera-monitor system to be classified as a device for indirect vision it would need to meet the prescribed field of view requirements in the new ADR for the applicable class of device (e.g. front-view device, close-proximity view device etc.) when fitted to the vehicle.

Allowing other devices for a driver to see objects in an area adjacent to the vehicle and monitoring devices to detect other road users in close proximity to the vehicle to protrude up to 100 mm in total (left + right side) beyond the measured width of the vehicle is unlikely to significantly increase the risk of sideswipe collisions with other vehicles or roadside infrastructure. This is because the ADR for rear vision mirrors already allows such mirrors to project up to 230 mm on each side beyond the point from which the vehicle width is measured, provided the mirrors are capable of collapsing to within 150 mm. This means the distance measured across rigid parts to which rear vision mirrors are attached (e.g. metal attachment plates, arms, swivel joints etc.) can already be up to 2.8 m (i.e. 150 mm on either side of a 2.5 m wide vehicle). Further, rear vision mirrors meeting the requirements of the UN Regulation in Appendix A (UN R46) of this ADR, are allowed to protrude up to 250 mm beyond the measured vehicle width (if necessary to comply with field of vision requirements), and are only subject to pendulum impact test requirements where the protrusion beyond the vehicle bodywork exceeds 100 mm.



All the devices and systems that are proposed to be excluded from vehicle width and length measurements would continue to be subject to the existing ADR requirements for external projections. These require exterior objects such as these to be designed and fitted in such a way as to minimise the risk of bodily injury to a person hit by or brushing against the bodywork of a vehicle in the event of a collision. These existing ADR requirements will therefore also serve to limit any risks associated with excluding each of the additional devices/systems as outlined in this proposal (above), from vehicle width and length measurements.

If this package of changes is implemented, further exclusions from vehicle width and/or length measurements could still be considered at a later stage as part of the ongoing ADR review process.

Regulatory package for safer wider heavy freight vehicles

Allowing wider vehicles would reduce the costs of modification of vehicles for the Australian market as well as provide the necessary space to better fit EU mandated safety technologies (such as blind spot information systems) and EU and US mandated environmental technologies (such as Euro VI or equivalent emission control systems) to reduce noxious emissions.

The Department is seeking any feedback/comments on four options to allow for safer (and cleaner) wider heavy freight vehicles to be supplied in Australia. Each of these includes a package of new safety ADRs to be mandated for the wider goods vehicles (those exceeding the current 2.5 m limit). The devices/systems selected for the safety packages are all covered by international (UN) vehicle regulations, and include the existing ADR development priorities for heavy vehicles under the National Road Safety Action Plan 2018-2020 (Australian Government, 2018a), as well as technologies targeted at reducing collisions between heavy vehicles and other road users in close-proximity to these vehicles. For goods vehicles over 4.5 tonnes GVM, these include devices for indirect vision, Electronic Stability Control (ESC), Advanced Emergency Braking (AEB), Lane Departure Warning Systems (LDWS), Blind Spot Information Systems, Lateral Protection Devices for side underrun protection, and conspicuity markings. For trailers over 4.5 tonnes, these include Lateral Protection Devices for side underrun protection, conspicuity markings and reversing lamps. More information on the safety devices/systems proposed to be included as part of a package of new safety ADRs (for wider vehicles) is provided in Appendices 3 to 9.

Option 1a – Increase the width limit to 2.55 m for goods vehicles and trailers over 4.5 tonnes

Under this option:

- The vehicle width limit for goods vehicles (i.e. trucks) over 4.5 tonnes GVM and trailers over 4.5 tonnes ATM (ADR category NB2, NC, TC (over 4.5 tonnes) and TD vehicles), would be increased from 2.5 m to 2.55 m.
- Permanently fixed webbing-assembly-type devices (such as curtain-side devices) would be excluded from the measurement of the vehicle width, provided the maximum distance across the body of the vehicle, including any part of the devices, is not more than 2.6 m.

- 
- The wider goods vehicles (those exceeding the current 2.5 m limit) would be required to:
 - meet a new ADR 14/03 – Devices for indirect vision (refer Appendix 3), incorporating the technical requirements of the latest version of the relevant international standard (UN R46/04), with additional provisions to allow for US style crossover mirrors (refer Glossary in Appendix 1) to be used on bonneted trucks in place of UN style front-view mirrors, provided these allow the driver to see at least 900 mm past the extreme outer edge of the left-hand (near) side of the vehicle;
 - meet a new ADR 35/07 – Commercial Vehicle Brake Systems, which is currently being developed to extend the scope of the mandatory ESC requirements (referred to in the ADR as a Vehicle Stability Function) to apply to a broader range of heavy vehicles (refer Appendix 4) – note: this would include exemptions from fitting ESC to trucks with four or more axles and trucks designed for off-road use, as per UN R13 and ADR 35/06;
 - meet a new ADR 97/00 – Advanced Emergency Braking (refer Appendix 5) for Omnibuses, and Medium and Heavy Goods Vehicles, incorporating the technical requirements of the latest version of the relevant international standard (UN R131/01) – note: this would include exemptions for trucks with four or more axles and trucks designed for off-road use, as per the EU requirements and as recommended in UN R131;
 - meet a new ADR 99/00 – Lane Departure Warning Systems (refer Appendix 6), incorporating the technical requirements of the relevant international standard (UN R130) – note: this would include exemptions for trucks with four or more axles and trucks designed for off-road use, as per the EU requirements and as recommended in UN R130;
 - meet a new ADR 105/00 – Blind Spot Information Systems (refer Appendix 7), incorporating the technical requirements of the relevant international standard (UN R151) – note: this ADR would only apply to goods vehicles over 8 tonnes GVM, as per UN R151 (and from a later date than the other proposed new ADRs – see below);
 - meet a new ADR 106/00 – Side Underrun Protection (refer Appendix 8), incorporating the technical requirements of the latest version of the relevant international standard (UN R73/01) – note: this ADR would not apply to prime movers, as per UN R73; and
 - if over 7.5 tonnes GVM (and excluding prime movers), be fitted with conspicuity markings (refer Appendix 9) in accordance with ADR 13/00 (or any later version of this ADR).
 - The wider trailers (those exceeding the current 2.5 m limit) would be required to:
 - meet a new ADR 106/00 – Side Underrun Protection (refer Appendix 8), incorporating the technical requirements of the latest version of the relevant international standard (UN R73/01); and
 - be fitted with conspicuity markings (refer Appendix 9) and reversing lamps in accordance with ADR 13/00 (or any later version of this ADR).



The new ADRs/ADR requirements for devices for indirect vision, AEB, ESC, LDWS, and side underrun protection, would be mandatory for goods vehicles exceeding the current 2.5 m width limit (with some limited exemptions – as noted above), from the same date the ADR amendment to allow wider vehicles (under standard approval processes) commences. These ADRs/ADR requirements would all be optional for vehicles not exceeding the current 2.5 m width limit, unless mandated through a separate ADR development process (e.g. as is currently being considered for AEB for heavy vehicles) to this proposal or where already a mandatory requirement (e.g. ESC for prime movers and shorter wheelbase rigid trucks). The same principles would be applied in regard to the applicability of the new ADRs for wider trailers – these would be mandatory for trailers exceeding the current 2.5 m width limit, and optional for trailers within the current limit (unless mandated through a separate ADR development process to this proposal).

It is proposed the new ADR for blind spot information systems (for detection of bicycles) would be mandatory for new heavy goods vehicles over 8 tonnes GVM and exceeding the current 2.5 m width limit, from 1 July 2024 for new models and 1 January 2025 for those models existing in the market prior to the new models date (1 July 2024). This is because this is a relatively new UN regulation, which will not be mandatory for all new heavy goods vehicles (over 8 tonnes maximum permissible mass) in the EU until July 2024.

If this option is implemented, a special allowance for refrigerated bodywork up to 2.6 m wide and/or a more general move to a 2.6 m width limit could still be considered at a later stage.

Option 1b – Increase the width limit to 2.55 m for goods vehicles over 4.5 tonnes only

Under this option:

- The vehicle width limit for goods vehicles (i.e. trucks) over 4.5 tonnes GVM (ADR category NB2 and NC vehicles), would be increased from 2.5 m to 2.55 m.
- Permanently fixed webbing-assembly-type devices (such as curtain-side devices) would be excluded from the measurement of the vehicle width, provided the maximum distance across the body of the vehicle, including any part of the devices, is not more than 2.6 m.
- The wider goods vehicles (those exceeding the current 2.5 m limit) would be required to meet each of the proposed new ADRs / ADR requirements listed for goods vehicles under Option 1a above.

If this option is implemented, a special allowance for refrigerated bodywork up to 2.6 m wide and/or a more general move to a 2.6 m width limit for goods vehicles and/or trailers could still be considered at a later stage.



Option 2a – Increase the width limit to 2.6 m for goods vehicles and trailers over 4.5 tonnes

Under this option:

- The vehicle width limit for goods vehicles (i.e. trucks) over 4.5 tonnes GVM and trailers over 4.5 tonnes ATM (ADR category NB2, NC, TC (over 4.5 tonnes) and TD vehicles), would be increased from 2.5 m to 2.6 m.
- Permanently fixed webbing-assembly-type devices (such as curtain-side devices) would be excluded from the measurement of the vehicle width, provided the maximum distance across the body of the vehicle, including any part of the devices, is not more than 2.65 m.
- The wider goods vehicles (those exceeding the current 2.5 m limit) would be required to meet each of the proposed new ADRs listed for goods vehicles under Option 1a above.
- The wider trailers (those exceeding the current 2.5 m limit) would be required to meet each of the proposed new ADRs / ADR requirements listed for trailers under Option 1a above.

Option 2b – Increase the width limit to 2.6 m for goods vehicles over 4.5 tonnes only

Under this option:

- The vehicle width limit in the ADRs for goods vehicles (i.e. trucks) over 4.5 tonnes GVM (ADR category NB2 and NC vehicles), would be increased from 2.5 m to 2.6 m.
- Permanently fixed webbing-assembly-type devices (such as curtain-side devices) would be excluded from the measurement of the vehicle width, provided the maximum distance across the body of the vehicle, including any part of the devices, is not more than 2.65 m.
- The wider goods vehicles (those exceeding the current 2.5 m limit) would be required to meet each of the proposed new ADRs / ADR requirements listed for goods vehicles under Option 1a above.

If this option is implemented, an increased (2.55 or 2.6 m) width limit for trailers could still be considered at a later stage.

Regulatory package for vehicles with more efficient and/or productive axle configurations

To facilitate a greater supply and take up of more efficient and/or productive freight vehicles, including vehicles with twin steer axles, retractable axles and quad axles, the Department is seeking any feedback/comments on a proposal to amend the ADRs to:

- Increase the maximum permissible distance between the centrelines of the axles of a twin steer axle group from 2.0 m to 2.5 m.
- Increase the transition mass limits by which retractable axles must automatically lower to match the general mass limits for heavy vehicle operators under the *Heavy Vehicle (Mass, Dimension and Loading) National Regulation* – as per the values in Table 1 above.

- Increase the maximum permissible rear overhang as a percentage of the wheelbase from 60 per cent to 70 per cent, for goods vehicles over 12 tonnes GVM (ADR category NC vehicles), provided the mass transmitted by the front steering axle(s) to the ground is at least 20 per cent of the total vehicle mass, when the vehicle is loaded to its GVM, with the load so distributed over the load bearing area of the vehicle as not to exceed the manufacturer's nominated gross axle load ratings.
- Allow for the fitment of a quad axle group (combination of 4 axles) in which the front and rear axles are more than 3.2 m, but not more than 4.9 m apart, to semi-trailers over 10 tonnes GVM (ADR category TD semi-trailers), provided the front or rear axle of the group is a steerable axle with at least ± 12 degrees of steering articulation and has an effective automatic centring mechanism.
- Include transition mass limits by which quad axle groups with one or more retractable axles must automatically transition from 3 to 4 lowered (fully-down) axles (also to match the general mass limits for heavy vehicle operators under the *Heavy Vehicle (Mass, Dimension and Loading) National Regulation*).

Increasing the maximum permissible spacing between the axles of a twin steer axle group from 2.0 m to 2.5 m should be sufficient for manufacturers to avoid the need to reduce the twin steer axle spacing for vehicles imported to Australia, without any negative impact on roads and bridges. This is supported by a bridge impact assessment undertaken by the NHVR, which compared the impacts on both simply supported and continuous span bridges (up to a 60 m span length) for vehicles with increased twin steer axle spacing (up to 2.5 m) relative to existing (ADR compliant) reference vehicles. This assessment demonstrated that in all cases, the impacts on bridges were equal to or less than the reference vehicles.

Increasing the transition mass limits by which retractable axles must automatically lower, to match the applicable general mass limits in-service (for all tyre and axle configurations), would increase the benefits available to operators (e.g. reduced tyre wear, lower fuel consumption) to offset the disadvantages of purchasing vehicles with retractable axles (e.g. additional component costs and weight). This should not present any problems in terms of road or bridge loadings in-service, as the loads imposed on roads and bridges by vehicles with retractable axles would still be no greater than the current in-service limits for equivalent combinations of load carrying tyres and axles on vehicles without any retractable axle(s).

The proposed change to the rear overhang requirements should encourage increased uptake of prime movers with a trailing retractable axle, while also ensuring (in practice) that such vehicles will have sufficient load on the front steering axle to maintain effective directional control for any permissible loading of the vehicle up to the GVM.

Amending the ADRs to allow quad axle groups to be fitted to semi-trailers would likely encourage an increased uptake of these trailers, as they would be eligible for standard vehicle approvals (assuming all other requirements are met) under the MVSA (and RVSA to follow). PBS access arrangements, including higher group axle mass limits for the PBS network, could continue to be applied where these trailers meet the additional PBS requirements (e.g. road friendly suspension, dual tyres on each wheel etc.). This will enable operators to transport more heavy loads in fewer trips (at least across the PBS network), which should reduce overall crash risk, fuel consumption and noxious emissions.



If any or all of these proposed changes are implemented, further changes in regard to axle configuration and spacing, including a move to more performance based requirements, could still be considered at a later stage as part of the ongoing ADR review process.

Next steps

The publication of this discussion paper provides an opportunity for all interested parties, including states and territories, industry bodies, businesses, and road user groups, to respond by submitting comments to the Department.

Submissions close on **Wednesday 30 June 2021**. The Department will carefully review and consider the feedback from this consultation process, to help finalise each of the regulatory packages set out in this paper, and encourage an increased uptake of safer and/or more efficient heavy freight vehicles in Australia.

Any agreed increase to the vehicle width and/or rear overhang limits for heavy freight vehicles in the ADRs would require matching (or equivalent) changes to be made to the *Heavy Vehicle (Mass, Dimension and Loading) National Regulation* (Queensland Government, 2020b).

References

- American Association of State Highway and Transportation Officials (AASHTO) (2001). *A Policy on Geometric Design of Highways and Streets (Fourth Edition)*.
- AASHTO (2016). *A Policy on Design Standards – Interstate System*. Retrieved February 2021 from www.dot.state.al.us/dsweb/pdf/A%20Policy%20on%20Design%20Standards%20-%20Interstate%20System%20May%202016.pdf.
- ARTSA (2011). *Combination Vehicle Brake Code of Practice: Part 5—Review of Electronically-Controlled Brake Technologies for Heavy Vehicles*. Retrieved November 2020 from www.artsa.com.au/library.
- ATA (2016). *Heavy Vehicle Visibility Technical Advisory Procedure*. Retrieved December 2020 from www.truck.net.au/resource-tags/technical-advisory-procedures.
- Australian Government (2016a). *Motor Vehicle Standards Act 1989*. Retrieved November 2020 from www.legislation.gov.au/Details/C2016C00857.
- Australian Government (2016b). *Vehicle Standard (Australian Design Rule 43/04 – Vehicle Configuration and Dimensions) 2006*. Retrieved November 2020 from www.legislation.gov.au/Details/F2016C00480.
- Australian Government (2018a). *National Road Safety Action Plan 2018-2020*. Retrieved November 2020 from www.roadsafety.gov.au/action-plan/2018-2020.
- Australian Government (2018b). *Vehicle Standard (Australian Design Rule 35/06 – Commercial Vehicle Brake Systems) 2018*. Retrieved November 2020 from www.legislation.gov.au/Details/F2018L00664.
- Australian Government (2019). *Road Vehicle Standards Act 2018*. Retrieved November 2020 from www.legislation.gov.au/Details/C2019C00274.
- Australian Government (2020). *Vehicle Standard (Australian Design Rule – Definitions and Vehicle Categories) 2005*. Retrieved November 2020 from www.legislation.gov.au/Details/F2020C00937.
- Austroroads (2016). *Austroroads Guide to Road Design Part 3: Geometric Design*. Retrieved December 2020 from austroroads.com.au/safety-and-design/road-design/guide-to-road-design.
- Austroroads (2019). *Austroroads supports increasing heavy vehicle widths to 2550 mm*. Retrieved November 2020 from austroroads.com.au/latest-news/austroroads-supports-increasing-heavy-vehicle-widths-to-2550mm.
- EU (2019). *Commission Regulation (EU) No 1230/2012*. Retrieved November 2020 from eur-lex.europa.eu/legal-content/EN/TXT/?uri=CELEX%3A02012R1230-20191202.
- European Road Safety Observatory (2018). *Motorways 2018*. Retrieved February 2021 from ec.europa.eu/transport/road_safety/sites/roadsafety/files/pdf/ersosynthesis2018-motorways.pdf.

- 
- Highways England (2020). *CD 127 Cross-sections and headrooms*. Retrieved February 2021 from standardsforhighways.co.uk/dmrb/search/66f2661f-959d-4b13-8139-92fbd491cbcf.
- NHVR (2017). *Information Sheet on PBS combinations fitted with quad-axle groups*. Retrieved November 2020 from www.nhvr.gov.au/road-access/performance-based-standards/quad-axle-group-vehicle-combinations.
- NHVR (2019). *Performance Based Standards: An introduction for road managers*. Retrieved November 2020 from www.nhvr.gov.au/road-access/performance-based-standards.
- NHVR (2020). *Vehicle Safety and Environmental Technology Uptake Plan*. Retrieved January 2021 from <https://www.nhvr.gov.au/safety-accreditation-compliance/vehicle-standards-and-modifications/vehicle-safety-and-environmental-technology-uptake-plan>.
- Queensland Government (2020a). *Heavy Vehicle National Law*. Retrieved November 2020 from www.legislation.qld.gov.au/view/pdf/inforce/current/act-2012-hvnlq.
- Queensland Government (2020b). *Heavy Vehicle (Mass, Dimension and Loading) National Regulation*. Retrieved November 2020 from www.legislation.qld.gov.au/view/pdf/inforce/current/sl-2013-0077.
- SWOV Institute for Road Safety Research (1994). *Annex VII Road design standards of medians, shoulders and verges*. Retrieved February 2021 from www.swov.nl/sites/default/files/publicaties/rapport/r-94-07vii.pdf.
- UN (2010). *United Nations Regulation No. 104 – Uniform provisions concerning the approval of retro-reflective markings for vehicles of category M, N, and O*. Retrieved December 2020 from www.unece.org/trans/main/wp29/wp29regs101-120.html.
- UN (2011). *United Nations Regulation No. 73 – Revision 1 – Uniform provisions concerning the approval of vehicles with regard to their lateral protection devices (LPDS)*. Retrieved November 2020 from www.unece.org/trans/main/wp29/wp29regs61-80.html.
- UN (2013). *United Nations Regulation No. 130 – Uniform provisions concerning the approval of motor vehicles with regard to the Lane Departure Warning System (LDWS)*. Retrieved November 2020 from www.unece.org/trans/main/wp29/wp29regs121-140.html.
- UN (2014a). *United Nations Regulation No. 13 – Revision 8 – Uniform provisions concerning the approval of vehicles of categories M, N and O with regard to braking*. Retrieved November 2020 from www.unece.org/trans/main/wp29/wp29regs0-20.html.
- UN (2014b). *United Nations Regulation No. 131 – Revision 1 – Uniform provisions concerning the approval of motor vehicles with regard to the Advanced Emergency Braking Systems (AEBS)*. Retrieved November 2020 from www.unece.org/trans/main/wp29/wp29regs121-140.html.



UN (2014c). *United Nations Regulation No. 48 – Revision 12 – Uniform provisions concerning the approval of vehicles with regard to the installation of lighting and light-signalling devices*. Retrieved December 2020 from www.unece.org/trans/main/wp29/wp29regs41-60.html.

UN (2016). *United Nations Regulation No. 46 – Revision 6 – Uniform provisions concerning the approval of devices for indirect vision and of motor vehicles with regard to the installation of these devices*. Retrieved November 2020 from www.unece.org/trans/main/wp29/wp29regs41-60.html.

UN (2020a). *United Nations Regulation No. 150 – Uniform provisions concerning the approval of retro-reflective devices and markings for power-driven vehicles and their trailers*. Retrieved December 2020 from www.unece.org/trans/main/wp29/wp29regs141-160.html.

UN (2020b). *United Nations Regulation No. 151 – Uniform provisions concerning the approval of motor vehicles with regard to the Blind Spot Information Systems for the Detection of Bicycles*. Retrieved November 2020 from www.unece.org/trans/main/wp29/wp29regs141-160.html.

US Government (2020). *Part 658 of the US Code of Federal Regulations – Truck Size and Weight, Route Designations – Length, Width and Weight Limitations (23 CFR 658)*. Retrieved November 2020 from www.govinfo.gov/#citation.

Appendix 1 – Glossary

Advanced Emergency Braking (AEB)	A system that can automatically detect a potential forward collision and activate the vehicle braking system to decelerate the vehicle with the purpose of avoiding or mitigating a collision.
Aggregate Trailer Mass (ATM)	The total mass of the laden trailer when carrying the maximum load recommended by the manufacturer. This will include any mass imposed onto the drawing vehicle when the combination vehicle is resting on a horizontal supporting plane.
Antilock Brake System (ABS)	A portion of a service brake system that automatically controls the degree of rotational wheel slip relative to the road at one or more road wheels of the vehicle during braking.
Axle	One or more shafts positioned in a line across a vehicle, on which one or more wheels intended to support the vehicle turn.
Axle Group	Either a single axle, tandem axle group, triaxle group, or close coupled axle group.
B-Double	A combination of vehicles consisting of a prime mover towing two semi-trailers.
Blind Spot Information System	A system to inform the driver of a possible collision with another road user (e.g. vehicle, motorcycle, bicycle, pedestrian etc.) in close proximity to the vehicle.
Close Coupled Axle Group	Two axles with centres not more than 1.0 m apart (regarded under the ADRs as a single axle); three axles with centres not more than 2.0 m apart (regarded under the ADRs as a tandem axle group); or four or more axles with centres not more than 3.2 m apart (regarded under the ADRs as a tri-axle group).
Conspicuity Marking	A device intended to increase the conspicuity of a vehicle, when viewed from the side or rear (or in the case of trailers, additionally from the front), by the reflection of light emanating from a light source not connected to the vehicle.
Converter Dolly	A trailer with an axle group and a fifth wheel coupling near the middle of its load-carrying surface, designed to convert a semi-trailer into a dog trailer.

Crossover mirror	A mirror that can be adjusted to enable a driver to see all points on a transverse horizontal line that is 1 m above a flat horizontal portion of road, 300 mm forward of the front end of the vehicle, and extends across the full width of the vehicle.
Device for Indirect Vision	Devices intended to give a clear view of the rear, side or front of the vehicle within the fields of vision defined in UN R46. These can be conventional mirrors, camera-monitors or other devices able to present information about the indirect field of vision to the driver.
Dog Trailer	A trailer with two axle groups of which the front axle group is steered by connection to the drawing vehicle.
Electronic Stability Control	A vehicle stability function.
Fifth Wheel Assembly	A fifth wheel coupling including any turn-table, mounting plate, sliding assembly, load cell and other equipment mounted between the towing vehicle chassis and the trailer skid plate, but not including any attachment sections.
Fifth Wheel Coupling	A device, other than the skid plate and the kingpin (which are parts of a semi-trailer), used with a prime mover, semi-trailer or a converter dolly to permit quick coupling and uncoupling and to provide for articulation.
Front End	The foremost point on the vehicle including the bumper bar; over-riders; tow hook; and bull bar if standard equipment.
Gross Axle Load Rating (GALR)	The manufacturer's specified maximum axle load for each axle for which compliance with applicable ADRs has been or can be established.
Gross Combination Mass (GCM)	The value specified for the vehicle by the manufacturer as being the maximum of the sum of the GVM of the drawing vehicle plus the sum of the axle loads of any vehicle capable of being drawn as a trailer.
Gross Vehicle Mass (GVM)	The maximum laden mass of a motor vehicle as specified by the manufacturer.
Gross Trailer Mass (GTM)	The mass transmitted to the ground by the axle or axles of the trailer when coupled to a drawing vehicle and carrying its maximum load approximately uniformly distributed over the load bearing area, and at which compliance with the appropriate ADRs has been or can be established.
Heavy Freight Vehicle	Any goods vehicles greater than 4.5 tonnes GVM or any trailer greater than 4.5 tonnes ATM.
Lane Departure Warning System	A system to warn the driver of an unintentional drift of the vehicle out of its travel lane.

Lateral Protection Device	A combination of longitudinal member(s) and link(s) (fixing elements) to the chassis side members or other structural parts of the vehicle, designed to offer effective protection to pedestrians, cyclists or motorcyclists against the risk of falling under the sides of the vehicle and being caught under the wheels. Parts of the vehicle can also be used as lateral protection devices.
Pig Trailer	A trailer having one axle group near the middle of the length of the goods-carrying surface.
Prescribed Transition Mass	The maximum permissible mass imposed by an axle group on the ground that causes a retractable axle to lower automatically to the fully-down position.
Prime Mover	A motor vehicle built to tow a semi-trailer.
Rigid Truck	A motor vehicle with a GVM greater than 4.5 tonnes constructed with a load carrying area. Includes a rigid truck with a tow bar, draw bar or other coupling on the rear of the vehicle.
Rear End	The rearmost point on the vehicle including the bumper bar, over-riders and tow hook or towbar if standard equipment.
Rear Overhang	The distance measured horizontally and parallel to the longitudinal axis of the vehicle between the rear end of the vehicle and the centre of the rear axle group (see Figure 8 above).
Retractable Axle	An axle with a means of adjustment enabling it to be raised or lowered relative to the other axles in the axle group.
Reversing Lamp	A lamp used to illuminate the road to the rear of the vehicle and to warn other road-users that the vehicle is reversing or about to reverse.
Section Width	The linear distance between the exteriors of the sidewalls of an inflated tyre, excluding elevations due to labelling, decoration, or protective bands.
Semi-trailer	A trailer that has one axle group or a single axle towards the rear; and a kingpin and skid plate at the front for coupling to the fifth wheel assembly of a prime mover, another semi-trailer or a converter dolly.
Single Axle	Either one axle, or two axles with centres between transverse, parallel, vertical planes spaced less than 1.0 m apart.
Tandem Axle Group	A group of at least two axles, in which the horizontal distance between the centrelines of the outermost axles is at least 1.0 m, but not more than 2.0 m.
Triaxle Group	A combination of three axles in which the front and rear axles are not less than 2.0 m and not more than 3.2 m apart.



Truck Tractor	A prime mover.
Twin Steer Axle Group	A group of 2 axles with single tyres; and fitted to a motor vehicle; and connected to the same steering mechanism; and the horizontal distance between the centre lines of which is at least 1.0 m, but not more than 2.0 m.
Vehicle Stability Function	An electronic control function for a vehicle that improves the dynamic stability of the vehicle.
Vision Support System	A system to enable the driver to detect and/or see objects in the area adjacent to the vehicle.
Wheelbase	The longitudinal distance between the centreline of the front axle and the centre of the rear axle group of a motor vehicle (see Figure 8 above).

Appendix 2 – Summary of vehicle width requirements by market

Australian width requirements (and exclusions)

- 2.5 m limit

Exclusions	Conditions
Rear vision mirrors	<p>May project up to 230 mm (on each side) beyond the vehicle width (without mirrors), if capable of collapsing to 150 mm.</p> <p>If less than 2 m above the ground when vehicle is loaded to its technically permissible maximum laden mass (i.e. GVM) – may project up to 250 mm (on each side) beyond the vehicle width (without mirrors), but only if necessary to comply with UN R46 field of view requirements.</p> <p>If more than 2 m above the ground when vehicle is loaded to its technically permissible maximum laden mass (i.e. GVM) – may project as much as necessary (on each side) to comply with UN R46 field of view requirements.</p>
Signalling devices Side-mounted lamps and reflectors	
Permanently fixed webbing-assembly-type devices such as curtain-side devices	The maximum distance measured across the body of the vehicle including any part of the devices must not exceed 2.55 m.
Anti-skid devices mounted on wheels Central tyre inflation systems Tyre pressure gauges	

EU (and UK) width requirements (and exclusions)

- 2.6 m limit for goods vehicles with refrigerated bodywork with insulated walls at least 45 mm thick
- 2.55 m limit for all other vehicles

Exclusions	Conditions
Devices for indirect vision as defined in UN R46	The devices and the vehicles they are fitted to must fully comply with UN R46.
The deflected part of the tyre walls at the point of contact with the road surface	
Tyre failure tell-tale devices Tyre-pressure indicators	Provided the total protrusion of the devices added to the width of the vehicle does not exceed 100 mm.
Side-marker lamps, end-outline marker lamps, side-retro-reflectors, direction indicator lamps, rear position lamps, service-door lighting systems	Provided the total protrusion of the devices added to the width of the vehicle does not exceed 100 mm.
Retractable lateral guidance devices intended for use on guided bus system	Excluded, if not retracted and provided the total protrusion of devices added to the width of the vehicle does not exceed 100 mm.
Retractable steps	Excluded, when vehicle is in a stand-still position and provided the total protrusion of devices added to the width of the vehicle does not exceed 100 mm.
Watching and detection aids including radars	Provided the total protrusion of the devices added to the width of the vehicle does not exceed 100 mm.
Devices and equipment especially designed to reduce aerodynamic drag	<p>Excluded, provided that they do not protrude by more than 50 mm on each side from the outermost width of the vehicle and they do not increase the loading capacity.</p> <p>Such devices must be designed to be retractable when the vehicle is at standstill in such a way that the maximum authorised width is not exceeded and they do not impair the capability of the vehicle to be used for intermodal transport.</p> <p>Where the devices and equipment are in service, the vehicle width must not exceed 2.65 m.</p>

Exclusions	Conditions
Customs sealing devices and their protection	Provided the total protrusion of the devices added to the width of the vehicle does not exceed 100 mm.
Devices for securing the tarpaulin and their protection	Excluded, provided they do not project more than 20 mm (on each side) where they are no more than 2 m from ground level, and no more than 50 mm (on each side) where they are more than 2 m from ground level. The edges must be rounded to a radius of not less than 2.5 mm.
Flexible parts of a spray-suppression system Flexible mudguards	Provided the total protrusion of the devices added to the width of the vehicle does not exceed 100 mm.
Safety railings on vehicle transporters	Excluded for vehicles designed and constructed to transport at least two other vehicles and for which the safety railings are more than 2.0 m, but not more than 3.7 m from the ground and do not project more than 50 mm from the outermost side of the vehicle. The vehicle width including the safety railings must not exceed 2.65 m.
Antennas used in vehicle-to-vehicle and vehicle-to-infrastructure communications	Provided the total protrusion of the devices added to the width of the vehicle does not exceed 100 mm.
Flexible hoses of tyre pressure monitoring systems	Provided they do not protrude by more than 70 mm on each side from the outermost width of the vehicle.

Japanese width requirements (and exclusions)

- 2.5 m limit

Exclusions	Conditions
Any outward-opening windows, ventilators, rear-view mirrors, and [other] devices for confirming rearward vision	Must not protrude 250 mm or more outwards from the outermost part of the motor vehicle.
Blind spot information systems for the detection of bicycles	Must not protrude more than 100 mm outwards from the outermost part of the motor vehicle.

New Zealand width requirements (and exclusions)

- 2.55 m limit

Exclusions	Conditions
Collapsible mirrors	Must not extend more than 240 mm beyond the side of the vehicle. Must not extend more than 1.49 m beyond the vehicle longitudinal centreline.
Side marker lamps and direction indicators	
Central tyre inflation systems	Must not extend more than 75 mm beyond the outside of the tyre on the drive axles of a heavy motor vehicle.
Hub odometers	Must not extend more than 50 mm beyond one side of a vehicle from a non-lifting, non-steering axle whose outer casings are of a light colour, provided the hub odometer is fitted on the axle that causes the least over width.
Cab exterior grab rails	Must not extend more than 1.325 m beyond the vehicle longitudinal centreline.
The bulge towards the bottom of a tyre	
Cameras or close-proximity monitoring systems mounted on the side exterior of a vehicle	Must not extend more than 70 mm from the sidewall of the vehicle.
Devices for improving the aerodynamic performance of a vehicle	Must not extend more than 25 mm from either side of a vehicle.

US width requirements (and exclusions)

- 2.6 m limit

Exclusions	Conditions
Rear view mirrors	
Turn signal lamps	
Handholds for cab entry/egress	
Splash and spray suppressant devices	
Load induced tyre bulge	
Non property carrying devices or components thereof	Provided the devices do not extend more than 3 inches (76 mm) beyond each side of the vehicle.

Appendix 3 – Devices for indirect vision

Devices for indirect vision are fitted to vehicles to give the driver a clear view of prescribed zones to the rear, side or front of the vehicle. These can be conventional mirrors, camera-monitors, or other devices able to present information about the indirect field of vision to the driver.

The recognised international standard for devices for indirect vision is the UN Regulation No. 46 (R46) – Uniform provisions concerning the approval of devices for indirect vision and of motor vehicles with regard to the installation of these devices (UN, 2016). It is applicable for passenger vehicles and goods vehicles (UN category M and N vehicles), as well as two-wheeled, three-wheeled and light quadricycle vehicles (UN L category vehicles) with enclosed bodywork.

UN R46 requires vehicles to be fitted with multiple devices for indirect vision to give the driver a clear view of prescribed fields of vision to the side, rear and front of the vehicle. The required fields of vision must be obtained from the minimum number of compulsory devices for indirect vision (i.e. mirrors or camera-monitor devices) set out in Table 2 below. Figure 11 shows the minimum required fields of vision to be provided by the devices for indirect vision for goods vehicles over 3.5 tonnes maximum mass. In addition, for goods vehicles over 7.5 tonnes, the field of vision must also be such that the driver can see the larger required view area (on the passenger side) shown in Figure 12 below. This additional area may be viewed using a combination of direct view, and indirect vision devices of classes IV (wide-angle view), V (close-proximity view), and/or VI (front-view).

Under UN R46, devices for indirect vision must not project substantially more beyond the vehicle bodywork than is necessary to comply with the field of vision requirements. Further, external mirrors that are less than 2 m above the ground (measured at the mirror lower edge with the vehicle at the maximum technically permissible mass) must not project more than 250 mm beyond the overall width of the vehicle (measured without mirrors). All devices for indirect vision, which are fitted less than 2 m above the ground, and protrude more than 100 mm from the vehicle bodywork, are required to meet pendulum impact test requirements.

For camera-monitor devices for indirect vision, the UN R46 requirements also include provisions for the image quality (e.g. maximum distortion, minimum frame rate, image formation time, system latency etc.), resolution and magnification, activation and de-activation, and the arrangement of the monitors in the vehicle (relative to the driver). There is no minimum or maximum number of camera-monitor devices for indirect vision.

Table 2 – Minimum number of devices for indirect vision for goods vehicles over 3.5 tonnes maximum mass

Class of device for indirect vision	Minimum number of compulsory devices for indirect vision
Class I (Rear-view device)	Optional (no requirements for the field of view)
Class II (Main rear-view device)	Compulsory 1 on the driver's side 1 on the passenger's side
Class III (Main rear-view device)	Not permitted
Class IV (Wide-angle view device)	Compulsory 1 on the driver's side 1 on the passenger's side
Class V (Close-proximity view device)	Compulsory 1 on the passenger's side ¹ ¹ Unless the required field of vision can be perceived through the combination of Class IV device and a Class VI device. Optional on the driver's side Mirrors must be at least 2 metres above the ground – a tolerance of 10 cm may be applied for goods vehicles ≤ 7.5 tonnes
Class VI (Front-view device)	Compulsory for goods vehicles over 7.5 tonnes 1 front-view device ^{2,3} ² A vision support system may instead be used for a vehicle that cannot fulfil this requirement using a front-view device, in which case the vision support system must be able to detect an object of 50 cm height and with a diameter of 30 cm within the required field of vision for a front-view device. ³ Not mandatory if the driver can see, taking into account the obstructions by the A-pillars, a straight line 300 mm in front of the vehicle at a height of 1,200 mm above the road surface and which is situated between a longitudinal vertical plane parallel to the longitudinal vertical median plane going through the outermost side of the vehicle at the driver's side and a longitudinal vertical plane parallel to the longitudinal vertical median plane 900 mm outside the outermost side of the vehicle opposite to the driver's side. Optional for goods vehicles ≤ 7.5 tonnes Mirrors must be at least 2 metres above the ground

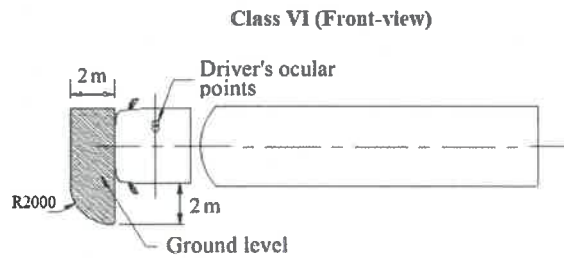
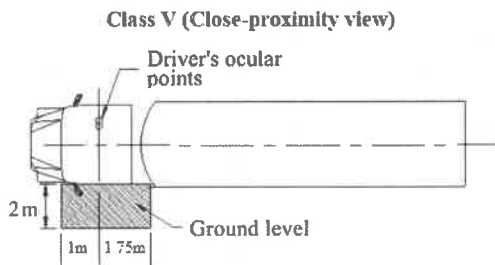
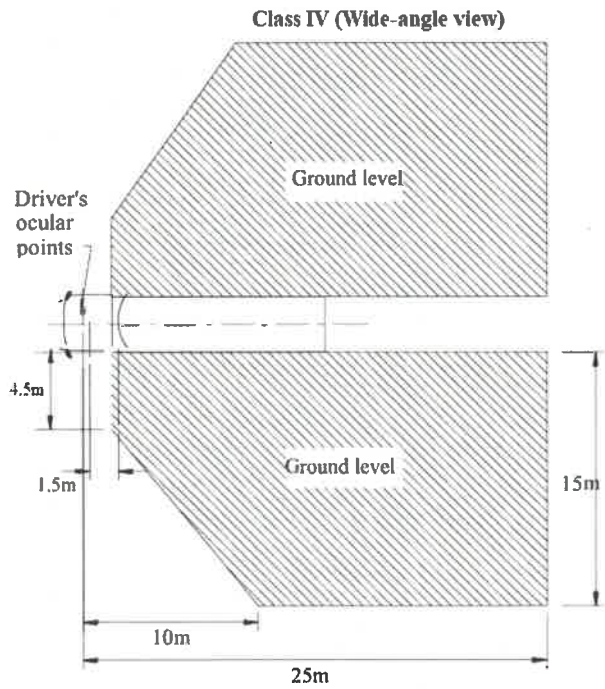
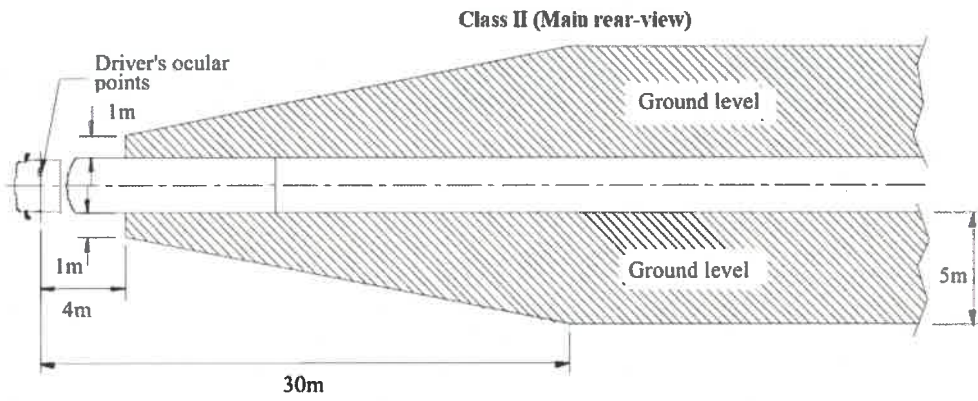

Figure 11 – Minimum required fields of vision for goods vehicles over 3.5 tonnes maximum mass (note: class VI is optional for goods vehicles ≤ 7.5 tonnes) (source: adapted (for right-hand-drive) from UN R46)

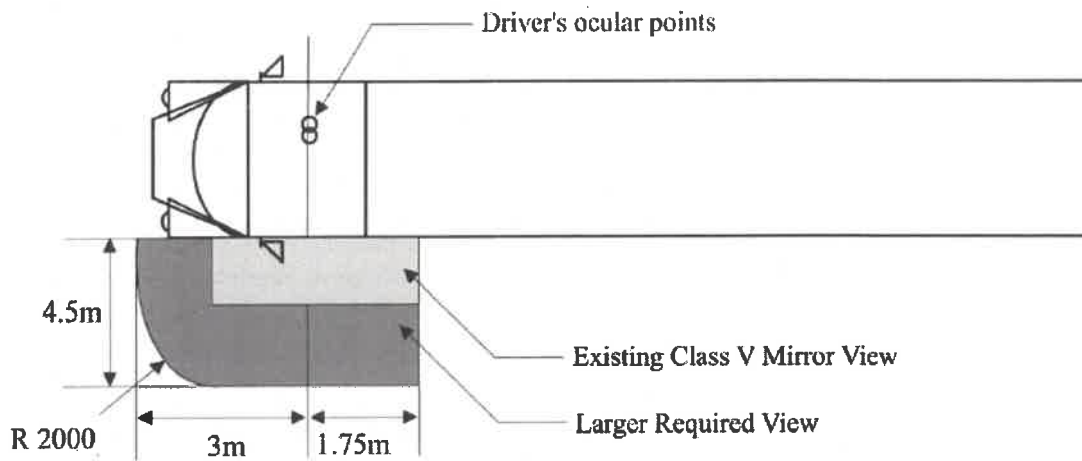

Figure 12 – Larger required field of vision on the passenger's side (note: required view may be achieved using a combination of direct view and indirect vision devices of classes IV, V, and/or VI) (source: adapted for right-hand-drive from UN R46)



Appendix 4 – Electronic Stability Control

Electronic Stability Control (ESC) systems for heavy vehicles are designed to reduce the number of crashes due to vehicle (or combination vehicle) understeer (ploughing out), oversteer (spinning out), and/or rollover. ESC systems for heavy vehicles typically consist of an electronic control unit that monitors data received from a steering-wheel-angle sensor, a combined yaw rate and lateral acceleration sensor, Antilock Brake System (ABS) wheel speed sensors, and load sensors, as well as the driver's control inputs to the steering and braking systems and to the engine, together with the engine output (e.g. torque and speed) and the vehicle speed.

Common causes of rollover crashes include entering corners at too high a speed, sudden steering manoeuvres to avoid other vehicles or obstacles and shifting of loads such as liquids in tanks. Heavy vehicles are usually much more prone to rollover than light vehicles, because they have a much higher gross mass together with an elevated centre of gravity.

Understeer or oversteer occur when there is not enough grip/friction between one or more tyres and the road to oppose lateral tyre forces. When the front tyres have utilised all available grip/traction the vehicle will tend to understeer (turn less sharply than the driver intends), and when the rear tyres have utilised all available grip/traction the vehicle will tend to oversteer (turn more sharply than the driver intends).

ESC systems for heavy vehicles automatically reduce engine torque and apply the vehicle (and any towed trailer) brakes, whenever the system determines based on the vehicle lateral acceleration and wheel speed sensor data that the vehicle is at risk of rolling over. ESC systems for heavy vehicles also automatically reduce engine torque and apply the vehicle (and/or any towed trailer) brakes, when the system determines based on the steering wheel angle and yaw rate sensor data that the vehicle is understeering or oversteering.

Understeer is typically corrected for by selective application of the inside rear brake(s) of the vehicle, while oversteer is typically corrected for by selective application of the outside front brake of the vehicle together with automatic application of any towed trailer brakes.



The rollover control function within heavy vehicle ESC systems also includes a learning function, to account for the considerable difference in the unladen and fully laden mass of these vehicles as well as significant variations in the load distribution (including on each axle and the load height/centre of gravity). The rollover control function is programmed with two pre-set lateral acceleration threshold (trigger) values. When the level one (lower) threshold is reached (or exceeded) (commonly 0.25g), the system will send a low-pressure test pulse to apply the brakes (ARTSA 2011). From these test pulses, the system determines based on the difference in wheel slip (measured by ABS wheel speed sensors) on each side of the vehicle how close the wheels on the inside of the turn are to leaving the ground. If it determines the wheels on the inside of the turn are close to lifting it will intervene to slow the vehicle/combination. If it determines the vehicle is not in danger of a rollover it will raise the level 1 lateral acceleration threshold a little, and will keep doing this until it determines the lateral acceleration is approaching a value slightly below that at which it must brake the vehicle (or vehicle combination) to avoid a rollover. Whenever the level two (higher) lateral acceleration threshold is reached (or exceeded), the system will intervene to slow the vehicle/combination. If the load condition changes (as indicated by axle load sensors) or the ESC system power is turned off (e.g. at an ignition cycle), the level one threshold is reset and the learning process repeats (ARTSA 2011). Engine torque data may also be used in the estimation of vehicle/combination mass.

The Australian Design Rule 35/06 – Commercial Vehicle Brake Systems (ADR 35/06) includes a mandatory requirement for ESC (referred to in the ADR as a Vehicle Stability Function) to be fitted to omnibuses over 5 tonnes GVM, prime movers over 12 tonnes GVM, cab-over engine vehicles over 12 tonnes GVM with a wheelbase not exceeding 4.5 m, and other (i.e. bonneted/ non-cab-over) goods vehicles over 12 tonnes GVM with a wheelbase not exceeding 5.0 m (i.e. shorter wheelbase rigid trucks). There are exemptions from mandatory ESC fitment for articulated omnibuses, route service omnibuses, heavy goods vehicles with four or more axles, and vehicles designed for off-road use (as defined in an Appendix to the ADR). ADR 35/06 is applicable (mandatory) from 1 November 2020 for new model omnibuses and goods vehicles over 3.5 tonnes GVM, and 1 January 2022 for all (new) omnibuses and goods vehicles over 3.5 tonnes GVM (Australian Government, 2018b).

ADR 35/06 includes performance based test requirements for omnibuses and prime movers over 12 tonnes GVM. These vehicles must either be approved to UN R13/11 or meet a detailed series of clockwise and anticlockwise J-turn tests and pass/fail criteria set out in the ADR. The J-turn test course consists of a straight entrance lane connected to a curved lane section. The straight section of the lane is 3.7 metres wide, and the curved section of the lane is 3.7 metres wide for prime movers and 4.3 metres wide for buses. Figure 13 shows an example of a suitable J-turn test course (configured for anticlockwise steering) for a prime mover.

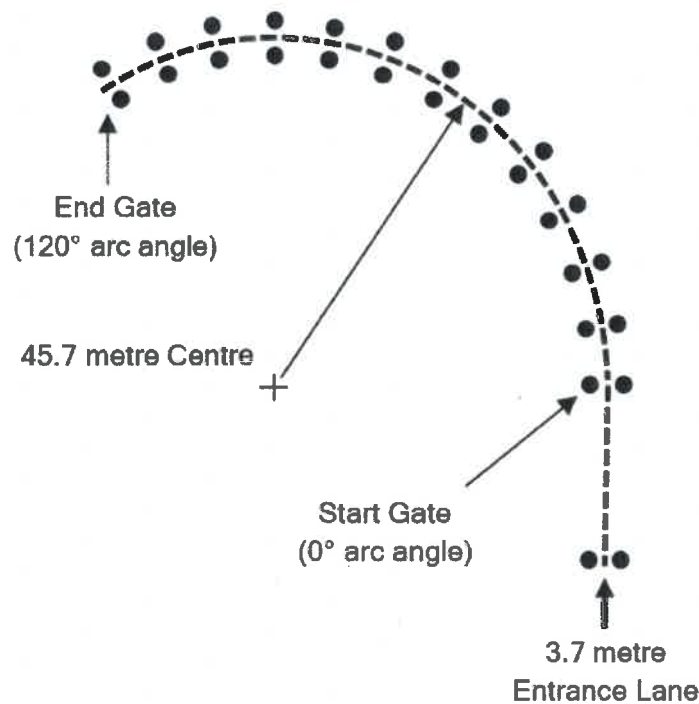



Figure 13 – Example of a suitable J-turn test course (in anticlockwise direction) for a prime mover

In each ADR 35/06 J-turn test, the test driver accelerates the vehicle along the entrance lane before crossing the start gate at a designated entrance speed. The driver then attempts to keep all wheels of the vehicle within the test track by steering the vehicle through the curved section of track without braking. The minimum lateral acceleration at which the ESC activates (i.e. intervenes) must be no greater than 0.4 g (which corresponds to an entrance speed of 48 km/h where a 45.7 m (150 feet) radius is used for the curved section of track). The vehicle must meet minimum deceleration requirements as it progresses through the test curve, at the vehicle's minimum ESC activation speed and at least 1.25 times the minimum ESC activation speed. The ESC system must also automatically reduce the driver-requested engine torque by at least 10 per cent when the vehicle is driven through the J-turn at an entrance speed equal to the vehicle's minimum ESC activation speed.



The recognised international standard for heavy vehicle braking is the UN Regulation No. 13 (R13) – Uniform provisions concerning the approval of vehicles of categories M, N and O with regard to braking (UN, 2014a). This regulation covers general braking including compatibility between towing vehicles and trailers, as well as ABS and ESC, and the fitment of standard connectors to provide power to electronic brake systems on trailers. To meet the latest version of this regulation (UN R13/11), omnibuses, and goods vehicles over 3.5 tonnes (with limited exemptions) must be equipped with an ESC system (also referred to in UN R13 as a Vehicle Stability Function) incorporating both directional control and rollover control. There are exemptions from ESC fitment for omnibuses with provisions for standing passengers, articulated omnibuses, heavy goods vehicles with more than three axles, vehicles designed for off-road use (UN category G vehicles – as defined in the UN Consolidated Resolution on the Construction of Vehicles), and special purpose vehicles.

Under UN R13/11, the rollover control function within heavy vehicle ESC systems is tested on and off in one of two test types. The directional control function within ESC systems is tested on and off in one of eight test types. However, the test procedures and pass/fail criteria are not defined in the regulation. These are instead determined through agreement between the UN approval authority and the vehicle manufacturer.

Both ADR 35/06 and UN R13/11 also include functional requirements to help ensure that ESC systems will work effectively for a wider range of instability scenarios than are simulated by the tests alone, as well as requirements for an optical warning signal to indicate ESC interventions to the driver and a warning signal to indicate any failure of this system.

Appendix 5 – Advanced Emergency Braking

Advanced Emergency Braking (AEB) systems for heavy vehicles are designed to avoid or mitigate the severity of rear end collisions with other vehicles in the same lane. Some systems can also detect and help to avoid collisions with pedestrians and/or bicyclists. AEB systems for heavy vehicles typically consist of an electronic control unit that monitors data received from camera and/or radar sensors at the front of the vehicle.

An AEB system for a heavy vehicle will first provide the driver with a forward collision warning, when it determines based on the vehicle camera and/or radar sensor data that the vehicle is at risk of a rear end collision with another vehicle in the same lane. If the driver does not react (from around 1.4 seconds of the first warning) to brake the vehicle, the AEB system will then commence an emergency braking phase to avoid or at least mitigate the severity of the impending collision. This is left as late as possible (within 3 seconds of a collision), including to allow the driver to steer (if appropriate) to avoid an impact, and to minimise the risk of the emergency braking phase commencing where not needed (e.g. through a false positive intervention). This means the deceleration can be very rapid and uncomfortable for a driver, especially as the vehicle gets closer to impact, which also serves to discourage drivers from adapting their behaviour to rely on AEB (which is a driver assistance system only) to brake for them. During any phase of action taken by the AEB system (i.e. the warning or emergency braking phases), the driver can at any time through a conscious action (e.g. by a steering action or an accelerator kick-down or operating the direction indicator control), take control and override the system.

The recognised international standard for AEB for heavy vehicles is the UN Regulation No. 131 (R131) – Uniform provisions concerning the approval of motor vehicles with regard to the Advanced Emergency Braking Systems (AEBS) (UN, 2014b). It is applicable for omnibuses (UN category M₂ and M₃ vehicles), and goods vehicles with a maximum mass over 3.5 tonnes (UN category N₂ and N₃ vehicles).

In the introduction (for information) of UN R131 it is noted that there are sub-groups of vehicles where the benefit is uncertain because they are primarily used in conditions other than highway conditions (e.g. buses with standing passengers, off-road vehicles and construction vehicles), and there are other sub-groups where the installation of AEB would be technically difficult regardless of the benefit (e.g. position of the sensor on off-road vehicles and special purpose vehicles, etc.). This information is provided to assist countries to decide which vehicles (if any) to exempt when incorporating this UN regulation into regional or national law. For example, the EU has exemptions (in EU regional law) from the fitment of AEB for buses with provision for standing passengers, vehicles with more than three axles, vehicles designed for off-road use (UN category G vehicles – as defined in the UN Consolidated Resolution on the Construction of Vehicles) and certain other special purpose vehicles.

To meet UN R131, an AEB system must be active at vehicle speeds above 15 km/h (unless manually deactivated). If a means (e.g. switch) is provided to manually deactivate the AEB system, the AEB function must be automatically re-instated at the start of each new ignition on (run) cycle, and a constant optical warning must be provided to inform the driver when the AEB system is deactivated. The performance of the AEB system is assessed in a stationary target test and a moving target test. The target vehicle used for both these tests must be a regular high volume series production passenger car, or a soft target representative of such a vehicle in terms of its identification characteristics. At the start of the functional part of each test the subject vehicle must be travelling at a speed of 80 ± 2 km/h and is at a distance of at least 120 m from the target vehicle. For goods vehicles at least two collision-warning modes must be provided in accordance with Table 3, before the commencement of the emergency braking phase. Any speed reduction during the warning phase must not exceed either 15 km/h or 30 per cent of the total subject vehicle speed reduction, whichever is higher. The emergency braking phase cannot start before the time to collision with the target vehicle is 3.0 seconds or less.

Table 3 – Summary of UN R131/01 collision warning mode, subject vehicle speed reduction, and moving test target speed requirements for goods vehicles

Subject vehicle	Stationary Target			Moving Target			
	Timing of warning modes/means		Speed Reduction	Timing of warning modes/means		Speed Reduction	Target Speed
	At least 1	At least 2		At least 1	At least 2		
Goods vehicles > 8 tonnes ¹	At least 1.4 s before the start of emergency braking	At least 0.8 s before the start of emergency braking	At least 20 km/h	At least 1.4 s before the start of emergency braking	At least 0.8 s before the start of emergency braking	No impact	12 ± 2 km/h
Goods vehicles > 3.5 tonnes and ≤ 8 tonnes ^{2,3,4}	At least 0.8 s before the start of emergency braking	Before the start of emergency braking	At least 10 km/h	At least 0.8 s before the start of emergency braking	Before the start of emergency braking	No impact	67 ± 2 km/h

¹ For goods vehicles > 8 tonnes, the acceptable warning modes/means are acoustic and haptic (e.g. vibration of the steering wheel).

² For goods vehicles > 3.5 tonnes and ≤ 8 tonnes, the acceptable warning modes/means are acoustic, haptic and visual.

³ All vehicles with pneumatic brake systems must meet the requirements for goods vehicles > 8 tonnes.

⁴ Goods vehicles > 3.5 tonnes and ≤ 8 tonnes may be certified to the requirements for goods vehicles > 8 tonnes in which case the requirements of the first row apply.



UN R131 also includes failure warning signal, deactivation warning signal, and false reaction tests for the AEB system. In the false reaction test, the subject vehicle is driven for a distance of at least 60 m, at a constant speed of 50 ± 2 km/h to pass centrally between two stationary passenger cars, a distance of 4.5 m apart and facing in the same direction of travel as the subject vehicle. To pass this test, the subject vehicle must not provide any collision warning or initiate any emergency braking phase/response.

Appendix 6 – Lane Departure Warning Systems

Lane Departure Warning Systems (LDWS) are designed to warn a drowsy or otherwise distracted or inattentive driver of an unintentional drift of the vehicle out of its travel lane. LDWS typically use camera and/or radar sensors to constantly monitor lane markings on the road ahead to detect any unintentional drift of the vehicle out of its lane. When an LDWS detects an unintentional lane departure, it will warn the driver using an escalating combination of visual, audible, and/or haptic (e.g. steering wheel vibration) alerts. LDWS will not provide a warning and will automatically deactivate, when the direction indicator is used. LDWS will usually also automatically deactivate when the vehicle is travelling along a road where the sensors cannot detect lane markings.

The recognised international standard for LDWS for heavy vehicles is UN Regulation No. 130 (R130) – Uniform provisions concerning the approval of motor vehicles with regard to the Lane Departure Warning System (LDWS). It is applicable for omnibuses (UN category M₂ and M₃ vehicles), and goods vehicles with a maximum mass over 3.5 tonnes (UN category N₂ and N₃ vehicles).

In the introduction (for information) of UN R130 it is noted that there are sub-groups of vehicles where the benefit is uncertain because they are primarily used in conditions other than highway conditions (e.g. buses with standing passengers, off-road vehicles and construction vehicles), and there are other sub-groups where the installation of LDWS would be technically difficult regardless of the benefit (e.g. vehicles equipped with split windshields, asymmetrical cabs, windshield of high thickness, front hood vehicles, vehicles with front mounted equipment, etc.). This information is provided to assist countries to decide which vehicles (if any) to exempt when incorporating this UN regulation into regional or national law. For example, the EU has exemptions (in EU regional law) from the fitment of LDWS for buses with provision for standing passengers, vehicles with more than three axles, vehicles designed for off-road use (UN category G vehicles – as defined in the UN Consolidated Resolution on the Construction of Vehicles) and certain other special purpose vehicles.

To meet UN R130, a LDWS must be active at vehicle speeds above 60 km/h (unless manually deactivated). If a means (e.g. switch) is provided to manually deactivate the LDWS, the LDWS function must be automatically re-instated at the start of each new ignition on (run) cycle, and a constant optical warning must be provided to inform the driver when the LDWS is deactivated. The LDWS is required (when active) to warn the driver if the vehicle crosses over a visible lane marking, when there has been no purposeful demand to do so (including for both straight sections, and curved sections having an inner lane marking with a radius ≥ 250 m). The performance of the LDWS is assessed in a series of four tests conducted at a speed of 65 ± 3 km/h. Two of these tests are performed by gently drifting the vehicle to the left, so that the vehicle crosses the lane markings at two different rates of departure within the range 0.1 to 0.8 m/s. The other two tests are performed by gently drifting the vehicle to the right, so that the vehicle crosses the lane markings at two different rates of departure within the range 0.1 to 0.8 m/s. In all tests, the required lane departure warnings must be provided before the outside of the tyre on the front wheel closest to the lane markings passes more than 0.3 m beyond the outside edge of the lane markings. UN R130 also includes failure warning signal and deactivation warning signal tests for the LDWS.

Appendix 7 – Blind Spot Information Systems

Blind Spot Information Systems (BSIS) are designed to inform the driver of a possible collision with another road user (e.g. vehicle, motorcycle, bicycle, or pedestrian) in close-proximity to the vehicle. BSIS typically use radar and/or camera sensors to detect other vehicles, pedestrians, and/or bicyclists in a zone (or zones) a driver is unable to see by direct vision alone. When a BSIS detects a potential collision it will warn the driver by means of visual, audible, and/or haptic (e.g. steering wheel vibration) alert(s).

The recognised international standard for BSIS is UN Regulation No. 151 (R151) - Uniform provisions concerning the approval of motor vehicles with regard to the Blind Spot Information System for the Detection of Bicycles (UN, 2020b). It is applicable for goods vehicles with a maximum mass over 8 tonnes (UN category $N_2 > 8$ tonnes and N_3 vehicles). Goods vehicles with a maximum mass between 3.5 and 8 tonnes (UN category N_2 vehicles ≤ 8 tonnes) and omnibuses (UN category M_2 and M_3 vehicles) may be approved at the request of the manufacturer. UN R151 only covers blind spot systems to inform the driver of a possible collision with a bicycle on the near side of a vehicle (the left side of a vehicle for left-hand traffic or the right side of a vehicle for right-hand traffic). It does not include requirements for systems to detect other vehicles and/or pedestrians, although manufacturers may use the same sensors (i.e. radars and/or cameras) to detect other road users in addition to bicyclists.

To meet UN R151 (UN, 2020b), a BSIS for the detection of bicyclists must be active for all forward vehicle speeds from standstill up to 30 km/h, and pass a range of dynamic and static performance tests. This includes a series of dynamic tests with the subject vehicle (i.e. the truck with BSIS fitted) passing a dummy bicyclist on the near side, at various subject vehicle and bicycle speeds, as well as various lateral separation distances between the subject vehicle and the dummy bicyclist. In each of these dynamic tests, the BSIS must provide a signal to inform the driver of the presence of a bicyclist before the subject vehicle crosses a prescribed line. Two different static tests are also conducted with the subject vehicle stationary and the bicyclist moving. In one of the static tests, the dummy bicyclist is moved in a perpendicular direction (from the near side) to pass in front of the stationary subject vehicle. In the other static test, the dummy bicyclist is moved in a parallel direction alongside the stationary subject vehicle (also on the near side). In each of these static tests, the BSIS must provide a signal to inform the driver of the presence of a bicyclist before the dummy bicyclist passes beyond a specified point (on each path of travel respectively). UN R151 also includes requirements for the BSIS to warn the driver by means of an optical (i.e. visual), acoustic, and/or haptic signal when the risk of a collision with a bicyclist increases. This warning signal must differ in mode or activation strategy from the initial information signal to inform the driver of the presence of a bicyclist. The BSIS must also automatically de-activate when it cannot operate properly due to contamination of its sensors (e.g. by mud, snow or ice) or in low light conditions, and must provide the driver with a failure warning whenever the system is in a state (including due to automatic deactivation) in which it will no longer meet the performance requirements of the regulation.

Appendix 8 – Side underrun protection

Side underrun protection can be provided on heavy freight vehicles through the installation of lateral protection devices (LPDs). These offer protection to pedestrians, cyclists or motorcyclists against the risk of falling under the sides of a goods vehicle or trailer, and being caught under the wheels, in particular when heavy vehicles are turning in urban areas. LPDs are made up of a combination of longitudinal member(s) and link(s) (fixing elements) to the chassis side members or other structural parts of the vehicle.

The recognised international standard for side underrun protection is the UN Regulation No. 73 (R73). – Uniform provisions concerning the approval of:

- I. Vehicles with regard to their lateral protection devices (LPD);
- II. Lateral protection devices (LPD); and
- III. Vehicles with regard to the installation of LPD of an approved type according to part II of this regulation.

UN R73 applies to goods vehicles and trailers with a maximum mass over 3.5 tonnes (UN category N₂, N₃, O₃, and O₄ vehicles). It does not apply to tractors for semi-trailers (i.e. prime movers) and vehicles designed and constructed for special purposes where it is not possible, for practical reasons, to fit LPDs.

Under UN R73, LPDs may consist of a continuous flat surface, or of one or more horizontal rails/members, or a combination of surfaces and rails. Further, components permanently affixed to the vehicle (e.g. fuel tanks, air tanks, tool boxes, battery boxes etc.) can be used as LPDs, as long as they comply with the design and performance requirements of the regulation. LPDs may also be designed to have several adjustment positions at the side of the vehicle, including for example to include elements that can be moved to provide access to storage space under the vehicle (e.g. for trailer gates, a spare wheel carrier etc.).

To meet UN R73, LPDs must not increase the overall width of the vehicle, or be any more than 150 mm inboard (at the main part of the outer surface) of the outermost planes between which the maximum vehicle width is measured. Further, the rear end (rearmost 250 mm) of an LPD must not be any more than 30 mm inboard of the outermost edge of the rear tyres (excluding any bulging of the tyres near the ground). Combinations of surfaces and rails must form a practically continuous LPD member from front to rear, with no more than a 25 mm gap permitted between adjacent components. Where horizontal rails are used in LPDs, these must be at least 50 mm high for UN category N₂ and O₃ vehicles, and at least 100 mm high for UN category N₃ and O₄ vehicles. The vertical gap between rails must not be any more than 300 mm.

Figure 14 and Figure 15 include example illustrations of the fitment of LPDs for a rigid truck and a semi-trailer respectively, including key UN R73 dimensional/position requirements. For all vehicles, the lower edge of the LPD must not be any more than 550 mm from the ground. The permissible gaps at the front, rear and upper edge of the LPD vary by vehicle category and design/purpose (e.g. truck, semi-trailer, full-trailer etc.). In the case of a vehicle having two steered axles, an LPD is not required between these axles if the longitudinal distance between the centrelines of the axles is no greater than 2.1 m.

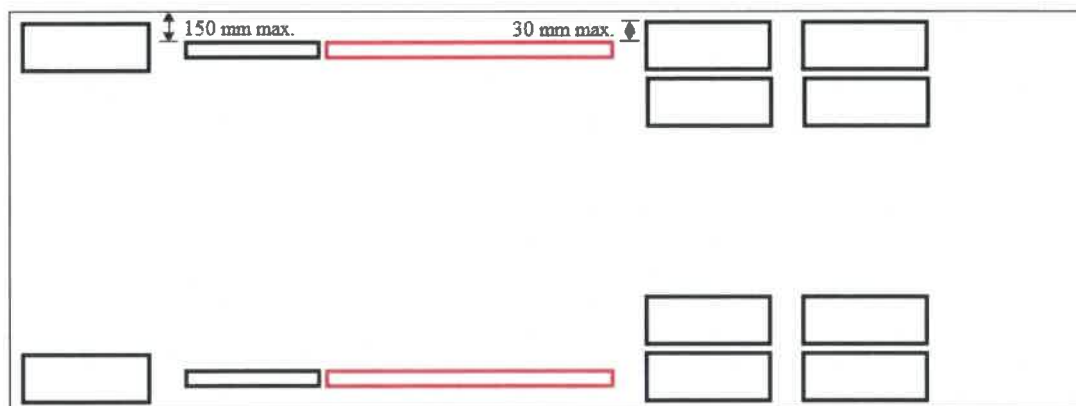
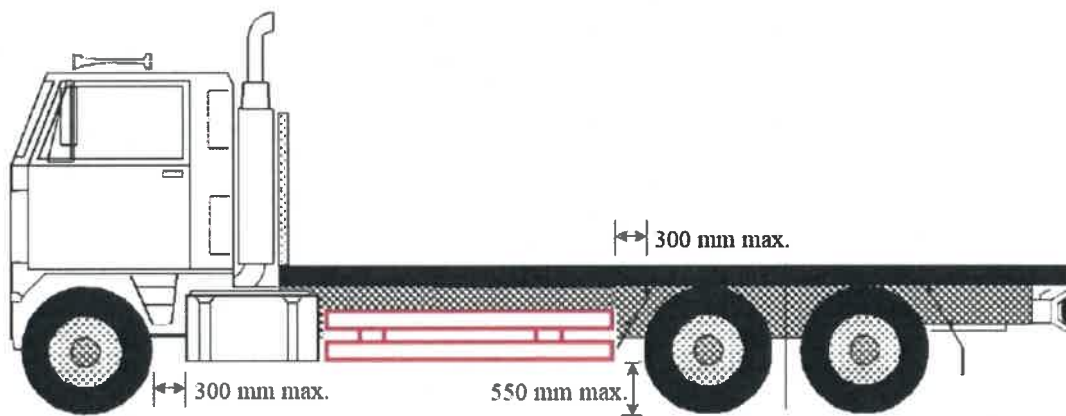

Figure 14 – Illustration (side view and overhead/plan view) of a rigid truck utilising fuel tanks and horizontal rails/members on each side as LPDs for side underrun protection, including key UN R73 dimensional limits

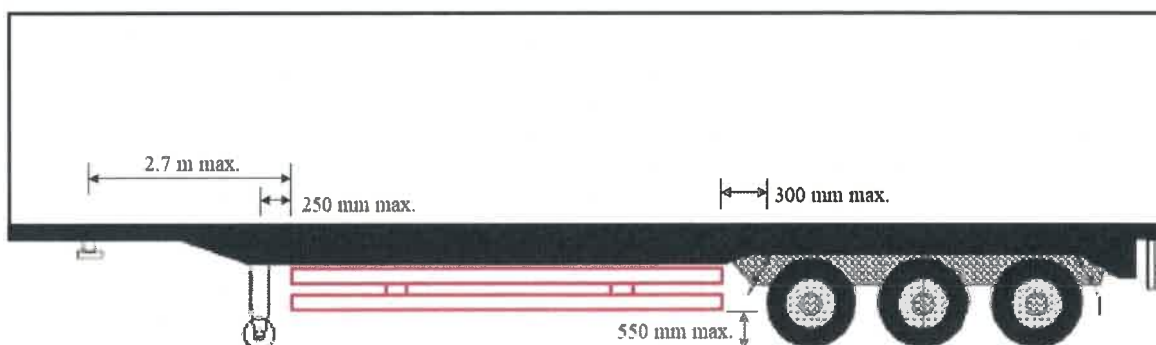



Figure 15 – Illustration (side view only) of a semi-trailer fitted with horizontal rails/members as LPDs for side underrun protection, including key UN R73 dimensional limits



To meet UN R73, LPDs must be capable of withstanding a horizontal static force of 1 kN applied perpendicularly to any part of their external surface by the centre of a ram, the face of which is circular and flat, with a diameter of 220 mm \pm 10 mm. The deflection of the LPD under load (measured at the centre of the ram) must not be more than 30 mm over the rearmost 250 mm of the LPD, and not more than 150 mm over the remainder of the LPD. This level of force has been set to ensure LPDs are sufficiently strong to be effective in collisions with vulnerable road users (in particular, pedestrians and bicyclists). LPDs may also provide some protection, for near parallel (i.e. sideswipe) collisions with light vehicles in adjacent lanes (e.g. during a lane departure), but this is not guaranteed. LPDs are not required to have sufficient structural strength to prevent the underrun of a passenger car in a side (i.e. lateral) impact crash.

UN R73 provides some exemptions/relaxations from the full requirements, for extendible trailers, tank vehicles (designed solely for the purpose of carrying fluids), vehicles fitted with extendible legs (for additional stability during loading/unloading), vehicles fitted with a crane, and in any case where the vehicle is designed/equipped that by their shape and characteristics the component parts together may be regarded as replacing the LPD. For example, extendible trailers need only comply with the full set of requirements when adjusted to the minimum length.

Appendix 9 – Conspicuity markings

Conspicuity markings can be fitted to heavy freight vehicles to make them easier for drivers of other vehicles to see at night (or in low light conditions), when viewed from the side or rear (or in the case of trailers, additionally from the front). Conspicuity markings include special material to reflect light emanating from the headlamps of another vehicle.

The UN Regulation No. 48 (R48) – Uniform provisions concerning the approval of vehicles with regard to the installation of lighting and light-signalling devices (UN, 2014c), is the recognised international standard for the fitment of conspicuity markings to road vehicles. The UN Regulation No. 104 (R104) – Uniform provisions concerning the approval of retroreflective markings for vehicles of categories M, N and O (UN, 2010), and the UN Regulation No. 150 (R150) – Uniform provisions concerning the approval of retro-reflective devices and markings for power-driven vehicles and their trailers (UN, 2020a), are the recognised international standards for the retroreflective material used for vehicle conspicuity markings.

Under UN R48 (UN, 2014c), conspicuity markings are categorised as either contour markings or line markings. Contour markings are used to indicate the horizontal and vertical dimensions (length, width and height) of a vehicle. Line markings are used to indicate the horizontal dimensions (length and width) of a vehicle by a continuous line. Contour markings are further categorised as either full contour markings or partial contour markings. Full contour markings indicate the outline of the vehicle by a continuous line. Partial contour markings indicate the horizontal dimension of the vehicle by a continuous line, and the vertical dimension by marking the upper corners. Conspicuity markings are considered continuous if the distance between adjacent elements is as small as possible and does not exceed 50 per cent of the shortest adjacent element length.

To meet UN R48 (UN, 2014c), goods vehicles over 7.5 tonnes maximum mass and trailers over 3.5 tonnes maximum mass, which are more than 2.1 m in overall width, must be fitted with full contour markings to the rear (with the exception of chassis-cabs, incomplete vehicles and tractors for semi-trailers (i.e. prime movers)). Further, goods vehicles over 7.5 tonnes maximum mass and trailers over 3.5 tonnes maximum mass, which are more than 6 m in length (including any drawbar for trailers), must be fitted with either partial or full contour markings to the side (with the exception of chassis-cabs, incomplete vehicles and tractors for semi-trailers (i.e. prime movers)). A line marking may be installed in place of a prescribed contour marking if the shape, structure, design or operational requirements of the vehicle make it impossible to install a contour marking. Line markings may be applied to the front of trailers. Partial or full contour markings must not be fitted at the front of any vehicle. Conspicuity markings must be white to the front (applies for optional front line markings on trailers only), white or yellow to the side, and red or yellow to the rear.

Under UN R48 (UN, 2014c), conspicuity markings must be fitted as close as practicable to horizontal and vertical, compatible with the shape, structure, design and operational requirements of the vehicle; or if this is not possible, the full or partial contour markings (when fitted), shall follow as close as practicable the contour of the outer shape of the vehicle. Further, the conspicuity markings must be spaced as evenly as possible over the horizontal dimensions of the vehicle, such that the total length and/or width of the vehicle can be identified. The conspicuity markings must reach as close as practicable to the front, side and rear edges (in width and length) of the vehicle, including within a prescribed limit of 600 mm of each end of the vehicle. Line and contour marking lower elements must be as low as practicable within the range, 250 mm to 1,500 mm above the ground level (unless approved to be higher (up to 2,500 mm) for practical reasons/limitations). Contour marking upper elements must be as high as practicable, but within 400 mm of the upper extremity of the vehicle.

Figure 16 shows an illustration of partial (yellow) contour markings on the side and full (red) contour markings on the rear of a semi-trailer. The Australian Trucking Association has published a Technical Advisory Procedure for heavy vehicle visibility, which includes further details and practical guidance, including examples/images for the application of conspicuity markings to a range of truck and trailer body configurations; including tankers, rubbish trucks, skip loaders, car carriers, and concrete agitators (ATA, 2016).

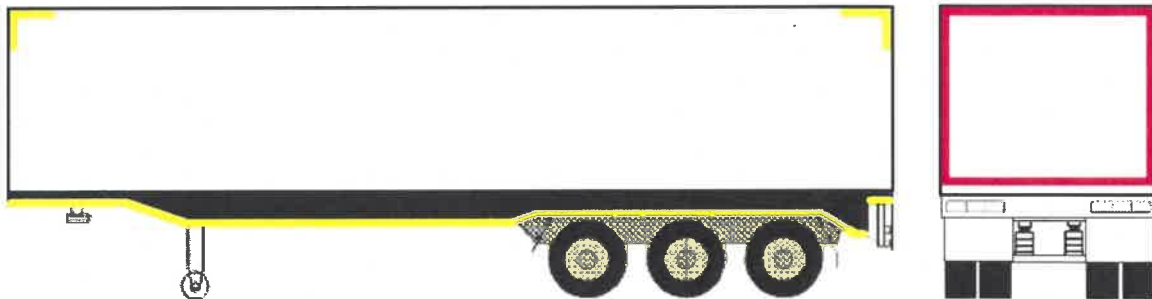

Figure 16 – Illustration of partial (yellow) contour markings on the side and full (red) contour markings on the rear of a semi-trailer